

HIGHLIGHTS OF PRESCRIBING INFORMATION

These highlights do not include all the information needed to use FULVESTRANT INJECTION safely and effectively. See full prescribing information for FULVESTRANT INJECTION, FULVESTRANT injection, for intramuscular use

Initial U.S. Approval: 2002

INDICATIONS AND USAGE

Fulvestrant injection is an estrogen receptor antagonist indicated for the treatment of:

- Hormone receptor (HR)-positive, human epidermal growth factor receptor 2 (HER2)-negative advanced breast cancer in postmenopausal women not previously treated with endocrine therapy. (1)
- HR-positive advanced breast cancer in postmenopausal women with disease progression following endocrine therapy. (1)
- HR-positive, HER2-negative advanced or metastatic breast cancer in postmenopausal women in combination with ribociclib, as initial endocrine based therapy or following disease progression on endocrine therapy. (1)
- HR-positive, HER2-negative advanced or metastatic breast cancer in combination with palbociclib or abemaciclib in women with disease progression after endocrine therapy. (1)

DOSAGE AND ADMINISTRATION

- Fulvestrant injection 500 mg should be administered intramuscularly into the buttocks (gluteal area) slowly (1 -2 minutes per injection) as two 5 mL injections, one in each buttock, on Days 1, 15, 29, and once monthly thereafter. (2.1, 14)
- A dose of 250 mg is recommended in patients with moderate hepatic impairment to be administered intramuscularly into the buttock (gluteal area) slowly (1 -2 minutes) as one 5 mL injection on Days 1, 15, 29, and once monthly thereafter. (2.2, 5.2, 8.6)

DOSAGE FORMS AND STRENGTHS

Fulvestrant injection, an injection for intramuscular administration, is supplied as 250 mg/5 mL fulvestrant. (3)

CONTRAINDICATIONS

- Hypersensitivity. (4)

WARNINGS AND PRECAUTIONS

- Risk of Bleeding: Use with caution in patients with bleeding diatheses, thrombocytopenia, or anticoagulant use. (5.1)
- Increased Exposure in Patients with Hepatic Impairment: Use a 250 mg dose for patients with moderate hepatic impairment. (2.2, 5.2, 8.6)
- Injection Site Reaction: Use caution while administering Fulvestrant injection at the dorsogluteal injection site due to the proximity of the underlying sciatic nerve. (5.3)
- Embryo-Fetal Toxicity: Can cause fetal harm. Advise females of reproductive potential of the potential risk to a fetus and to use effective contraception. (5.4, 8.1, 8.3)
- Immunoassay Measurement of Serum Estradiol: Fulvestrant injection can interfere with estradiol measurement by immunoassay, resulting in falsely elevated estradiol levels. (5.5)

ADVERSE REACTIONS

- The most common adverse reactions occurring in $\geq 5\%$ of patients receiving Fulvestrant injection 500 mg were: injection site pain, nausea, bone pain, arthralgia, headache, back pain, fatigue, pain in extremity, hot flash, vomiting, anorexia, asthenia, musculoskeletal pain, cough, dyspnea, and constipation. (6.1)
- Increased hepatic enzymes (ALT, AST, ALP) occurred in $>15\%$ of Fulvestrant injection patients and were not dose-dependent. (6.1)

To report SUSPECTED ADVERSE REACTIONS, contact Accord Healthcare Inc. at 1-866-941-7875 or FDA at 1-800-FDA-1088 or www.fda.gov/medwatch

DRUG INTERACTIONS

- There are no known drug-drug interactions. (7)

USE IN SPECIFIC POPULATIONS

- Lactation: Advise not to breastfeed. (8.2)

See 17 for PATIENT COUNSELING INFORMATION and FDA approved patient labeling.

Revised: 8/2020

FULL PRESCRIBING INFORMATION: CONTENTS*

1 INDICATIONS AND USAGE

2 DOSAGE AND ADMINISTRATION

- 2.1 Recommended Dose
- 2.2 Dose Modification
- 2.3 Administration Technique

3 DOSAGE FORMS AND STRENGTHS

4 CONTRAINDICATIONS

5 WARNINGS AND PRECAUTIONS

- 5.1 Risk of Bleeding
- 5.2 Increased Exposure in Patients with Hepatic Impairment
- 5.3 Injection Site Reaction
- 5.4 Embryo-Fetal Toxicity
- 5.5 Immunoassay Measurement of Serum Estradiol

6 ADVERSE REACTIONS

- 6.1 Clinical Trials Experience
- 6.2 Postmarketing Experience

7 DRUG INTERACTIONS

8 USE IN SPECIFIC POPULATIONS

- 8.1 Pregnancy

8.2 Lactation

8.3 Females and Males of Reproductive Potential

8.4 Pediatric Use

8.5 Geriatric Use

8.6 Hepatic Impairment

8.7 Renal Impairment

10 OVERDOSAGE

11 DESCRIPTION

12 CLINICAL PHARMACOLOGY

- 12.1 Mechanism of Action
- 12.2 Pharmacodynamics
- 12.3 Pharmacokinetics

13 NONCLINICAL TOXICOLOGY

- 13.1 Carcinogenesis, Mutagenesis, Impairment of Fertility

14 CLINICAL STUDIES

16 HOW SUPPLIED/STORAGE AND HANDLING

17 PATIENT COUNSELING INFORMATION

*Sections or subsections omitted from the full prescribing information are not listed.

FULL PRESCRIBING INFORMATION

1 INDICATIONS AND USAGE

Monotherapy

Fulvestrant injection is indicated for the treatment of:

- Hormone receptor (HR)-positive, human epidermal growth factor receptor 2 (HER2)-negative advanced breast cancer in postmenopausal women not previously treated with endocrine therapy, or
- HR-positive advanced breast cancer in postmenopausal women with disease progression following endocrine therapy.

Combination Therapy

Fulvestrant injection is indicated for the treatment of:

- HR-positive, HER2-negative advanced or metastatic breast cancer in postmenopausal women in combination with ribociclib as initial endocrine based therapy or following disease progression on endocrine therapy.
- HR-positive, HER2-negative advanced or metastatic breast cancer in combination with palbociclib or abemaciclib in women with disease progression after endocrine therapy.

2 DOSAGE AND ADMINISTRATION

2.1 Recommended Dose

Monotherapy

The recommended dose of Fulvestrant injection is 500 mg to be administered intramuscularly into the buttocks (gluteal area) slowly (1 -2 minutes per injection) as two 5 mL injections, one in each buttock, on Days 1, 15, 29, and once monthly thereafter [*see Clinical Studies (14)*].

Combination Therapy

When Fulvestrant injection is used in combination with palbociclib, abemaciclib, or ribociclib, the recommended dose of Fulvestrant injection is 500 mg to be administered intramuscularly into the buttocks (gluteal area) slowly (1 -2 minutes per injection) as two 5 mL injections, one in each buttock, on Days 1, 15, 29, and once monthly thereafter.

When Fulvestrant injection is used in combination with palbociclib, the recommended dose of palbociclib is a 125 mg capsule taken orally once daily for 21 consecutive days followed by 7 days off treatment to comprise a complete cycle of 28 days. Palbociclib should be taken with food. Refer to the Full Prescribing Information for palbociclib.

When Fulvestrant injection is used in combination with abemaciclib, the recommended dose of abemaciclib is 150 mg orally, twice daily. Abemaciclib may be taken with or without food. Refer to the Full Prescribing Information for abemaciclib.

When Fulvestrant injection is used in combination with ribociclib, the recommended dose of ribociclib is 600 mg taken orally, once daily for 21 consecutive days followed by 7 days off treatment resulting in a complete cycle of 28 days. Ribociclib can be taken with or without food. Refer to the Full Prescribing Information for ribociclib.

Pre/perimenopausal women treated with the combination of Fulvestrant injection plus palbociclib, abemaciclib, or ribociclib, should be treated with luteinizing hormone-releasing hormone (LHRH) agonists according to current clinical practice standards [see Clinical Studies (14)].

2.2 Dose Modification

Monotherapy

Hepatic Impairment:

A dose of 250 mg is recommended for patients with moderate hepatic impairment (Child-Pugh class B) to be administered intramuscularly into the buttock (gluteal area) slowly (1 -2 minutes) as one 5 mL injection on Days 1, 15, 29, and once monthly thereafter.

Fulvestrant injection has not been evaluated in patients with severe hepatic impairment (Child-Pugh class C) [see *Warnings and Precautions (5.2) and Use in Specific Populations (8.6)*].

Combination Therapy

When Fulvestrant injection is used in combination with palbociclib, abemaciclib, or ribociclib, refer to monotherapy dose modification instructions for Fulvestrant injection.

Refer to the Full Prescribing Information of co-administered palbociclib, abemaciclib, or ribociclib for dose modification guidelines in the event of toxicities, for use with concomitant medications, and other relevant safety information.

2.3 Administration Technique

Administer the injection according to the local guidelines for performing large volume intramuscular injections.

NOTE: Due to the proximity of the underlying sciatic nerve, caution should be taken if administering Fulvestrant injection at the dorsogluteal injection site [see *Warnings and Precautions (5.3) and Adverse Reactions (6.1)*].

The proper method of administration of Fulvestrant injection for intramuscular use is described in the following instructions.

For each single-dose prefilled syringe:

1. Remove glass syringe barrel from tray and check that it is not damaged.
2. Remove perforated patient record label from syringe.
3. Inspect drug product in glass syringe for any visible particulate matter or discoloration prior to use. Discard if particulate matter or discoloration is present.
4. Peel open the safety needle (SafetyGlide™) outer packaging.
5. Hold the syringe upright on the ribbed part (C). With the other hand, take hold of the cap (A) and carefully tilt cap back and forth (DO NOT TWIST CAP) until the cap disconnects for removal (see Figure 1).

Figure 1

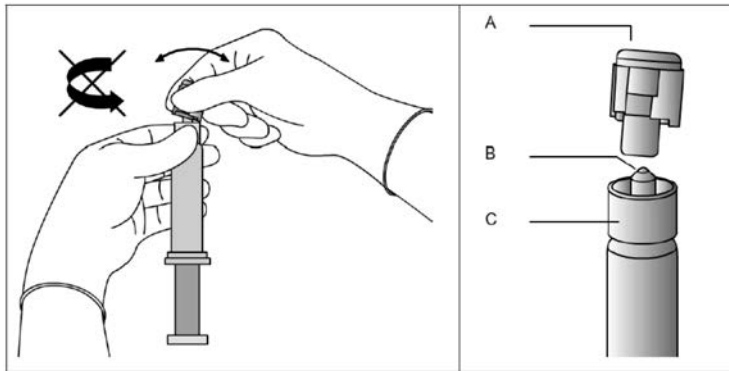

6. Pull the cap (A) off in a straight upward direction. DO NOT TOUCH THE STERILE SYRINGE TIP (Luer-Lok) (B) (see Figure 2).

Figure 2

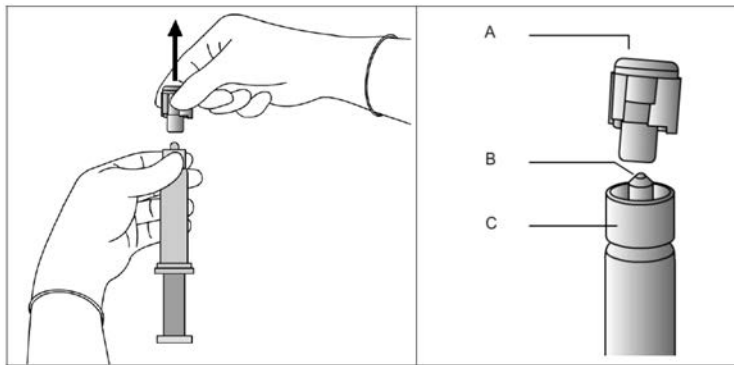

7. Attach the safety needle to the syringe tip (Luer-Lok). Twist needle until firmly seated (see Figure 3). Confirm that the needle is locked to the Luer connector before moving or tilting the syringe out of the vertical plane to avoid spillage of syringe contents.

Figure 3

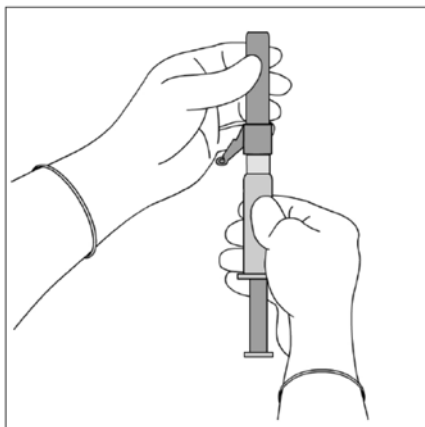

For Administration:

8. Pull shield straight off needle to avoid damaging needle point.
9. Remove needle sheath.
10. Expel excess gas from the syringe (a small gas bubble may remain).
11. Administer intramuscularly slowly (1-2 minutes/injection) into the buttock (gluteal area). For user convenience, the needle 'bevel up' position is orientated to the lever arm, as shown in Figure 4.

Figure 4

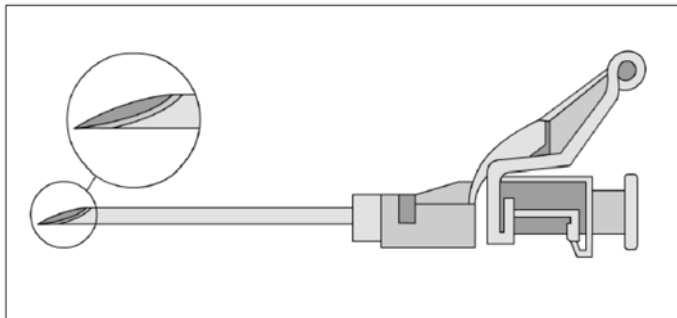

12. After injection, immediately activate the lever arm to deploy the needle shielding by applying a single-finger stroke to the activation assisted lever arm to push the lever arm completely forward. Listen for a click. Confirm that the needle shielding has completely covered the needle (see Figure 5). NOTE: Activate away from self and others.

Figure 5

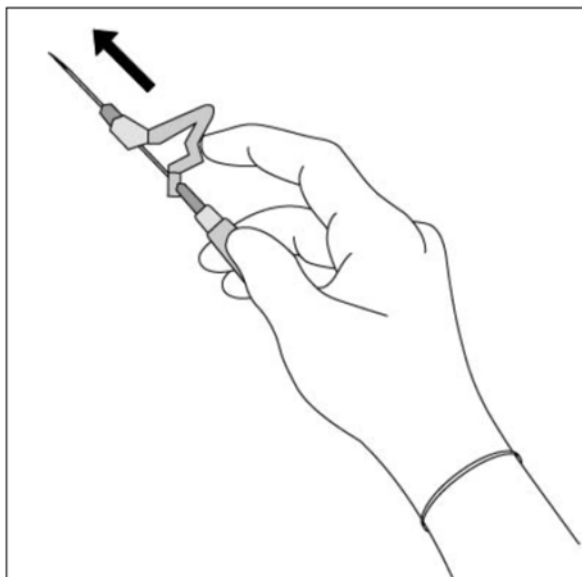

13. Discard the empty syringe into an approved sharps collector in accordance with applicable regulations and institutional policy.
14. Repeat steps 1 through 13 for second syringe.

How To Use Fulvestrant injection

For the 2 x 5 mL syringe package, the contents of both syringes must be injected to receive the 500 mg recommended dose.

SAFETYGLIDE™ INSTRUCTIONS FROM BECTON DICKINSON

SafetyGlide™ is a trademark of Becton Dickinson and Company.

Important Administration Information

To help avoid HIV (AIDS), HBV (Hepatitis), and other infectious diseases due to accidental needlesticks, contaminated needles should not be recapped or removed, unless there is no alternative or that such action is required by a specific medical procedure. Hands must remain behind the needle at all times during use and disposal.

Do not autoclave SafetyGlide™ Needle before use.

Becton Dickinson guarantees the contents of their unopened or undamaged packages to be sterile, non-toxic, and non-pyrogenic.

3 DOSAGE FORMS AND STRENGTHS

Fulvestrant injection, an injection for intramuscular administration, is supplied as 5-mL single-dose prefilled syringes containing 250 mg/5 mL fulvestrant.

4 CONTRAINDICATIONS

Fulvestrant injection is contraindicated in patients with a known hypersensitivity to the drug or to any of its components. Hypersensitivity reactions, including urticaria and angioedema, have been reported in association with Fulvestrant injection [*see Adverse Reactions (6.2)*].

5 WARNINGS AND PRECAUTIONS

5.1 Risk of Bleeding

Because Fulvestrant injection is administered intramuscularly, it should be used with caution in patients with bleeding diatheses, thrombocytopenia, or anticoagulant use.

5.2 Increased Exposure in Patients with Hepatic Impairment

The safety and pharmacokinetics of Fulvestrant injection were evaluated in a study in seven subjects with moderate hepatic impairment (Child-Pugh class B) and seven subjects with normal hepatic function. Exposure was increased in patients with moderate hepatic impairment, therefore a dose of 250 mg is recommended [*see Dosage and Administration (2.2)*].

Fulvestrant injection has not been studied in patients with severe hepatic impairment (Child-Pugh class C) [*see Use in Specific Populations (8.6)*].

5.3 Injection Site Reaction

Injection site related events including sciatica, neuralgia, neuropathic pain, and peripheral neuropathy have been reported with Fulvestrant injection. Caution should be taken while administering Fulvestrant injection at the dorsogluteal injection site due to the proximity of the underlying sciatic nerve [see *Dosage and Administration (2.3) and Adverse Reactions (6.1)*].

5.4 Embryo-Fetal Toxicity

Based on findings from animal studies and its mechanism of action, Fulvestrant injection can cause fetal harm when administered to a pregnant woman. In animal reproduction studies, administration of fulvestrant to pregnant rats and rabbits during organogenesis resulted in embryo-fetal toxicity at daily doses that are significantly less than the maximum recommended human dose. Advise pregnant women of the potential risk to a fetus. Advise females of reproductive potential to use effective contraception during treatment with Fulvestrant injection and for one year after the last dose [see *Use in Specific Populations (8.1), (8.3) and Clinical Pharmacology (12.1)*].

5.5 Immunoassay Measurement of Serum Estradiol

Due to structural similarity of fulvestrant and estradiol, Fulvestrant injection can interfere with estradiol measurement by immunoassay, resulting in falsely elevated estradiol levels.

6 ADVERSE REACTIONS

The following adverse reactions are discussed in more detail in other sections of the labeling:

- Risk of Bleeding [see *Warnings and Precautions (5.1)*]
- Increased Exposure in Patients with Hepatic Impairment [see *Warnings and Precautions (5.2)*]
- Injection Site Reaction [see *Warnings and Precautions (5.3)*]
- Embryo-Fetal Toxicity [see *Warnings and Precautions (5.4)*]

6.1 Clinical Trials Experience

Because clinical trials are conducted under widely varying conditions, the adverse reaction rates observed cannot be directly compared to rates in other trials and may not reflect the rates observed in clinical practice.

Monotherapy

Comparison of Fulvestrant 500 mg and Fulvestrant 250 mg (CONFIRM)

The following adverse reactions (ARs) were calculated based on the safety analysis of CONFIRM comparing the administration of Fulvestrant 500 mg intramuscularly once a month with Fulvestrant 250 mg intramuscularly once a month. The most frequently reported adverse reactions in the fulvestrant 500 mg group were injection site pain (11.6% of patients), nausea (9.7% of patients), and bone pain (9.4% of patients); the most frequently reported adverse

reactions in the fulvestrant 250 mg group were nausea (13.6% of patients), back pain (10.7% of patients), and injection site pain (9.1% of patients).

Table 1 lists adverse reactions reported with an incidence of 5% or greater, regardless of assessed causality, from CONFIRM.

Table 1: Adverse Reactions in CONFIRM ($\geq 5\%$ in Either Treatment Group)

Adverse Reactions	Fulvestrant 500 mg N=361 %	Fulvestrant 250 mg N=374 %
Body as a Whole		
Injection Site Pain ¹	12	9
Headache	8	7
Back Pain	8	11
Fatigue	8	6
Pain in Extremity	7	7
Asthenia	6	6
Vascular System		
Hot Flash	7	6
Digestive System		
Nausea	10	14
Vomiting	6	6
Anorexia	6	4
Constipation	5	4
Musculoskeletal System		
Bone Pain	9	8
Arthralgia	8	8
Musculoskeletal Pain	6	3
Respiratory System		
Cough	5	5
Dyspnea	4	5

1. Including more severe injection site related sciatica, neuralgia, neuropathic pain, and peripheral neuropathy.

In the pooled safety population (N=1127) from clinical trials comparing Fulvestrant 500 mg to Fulvestrant 250 mg, post-baseline increases of ≥ 1 CTC grade in either AST, ALT, or alkaline phosphatase were observed in $>15\%$ of patients receiving Fulvestrant. Grade 3-4 increases were observed in 1-2% of patients. The incidence and severity of increased hepatic enzymes (ALT, AST, ALP) did not differ between the 250 mg and the 500 mg Fulvestrant arms.

Comparison of Fulvestrant 500 mg and Anastrozole 1 mg (FALCON)

The safety of Fulvestrant 500 mg versus anastrozole 1 mg was evaluated in FALCON. The data described below reflect exposure to Fulvestrant in 228 out of 460 patients with HR-positive advanced breast cancer in postmenopausal women not previously treated with endocrine therapy who received at least one (1) dose of treatment in FALCON.

Permanent discontinuation associated with an adverse reaction occurred in 4 of 228 (1.8%) patients receiving Fulvestrant and in 3 of 232 (1.3%) patients receiving anastrozole. Adverse

reactions leading to discontinuation for those patients receiving Fulvestrant included drug hypersensitivity (0.9%), injection site hypersensitivity (0.4%), and elevated liver enzymes (0.4%).

The most common adverse reactions ($\geq 10\%$) of any grade reported in patients in the Fulvestrant arm were arthralgia, hot flash, fatigue, and nausea.

Adverse reactions reported in patients who received Fulvestrant in FALCON at an incidence of $\geq 5\%$ in either treatment arm are listed in Table 2, and laboratory abnormalities are listed in Table 3.

Table 2: Adverse Reactions in FALCON

Adverse Reactions	Fulvestrant 500 mg N=228		Anastrozole 1mg N=232	
	All Grades %	Grade 3 or 4 %	All Grades %	Grade 3 or 4 %
Vascular Disorders				
Hot flash	11	0	10	0
Gastrointestinal Disorders				
Nausea	11	0	10	<1
Diarrhea	6	0	6	<1
Musculoskeletal and Connective Tissue Disorders				
Arthralgia	17	0	10	0
Myalgia	7	0	3	0
Pain in extremity	6	0	4	0
Back pain	9	<1	6	0
General Disorders and Administration Site Conditions				
Fatigue	11	<1	7	<1

Table 3: Laboratory Abnormalities in FALCON¹

Laboratory Parameters	Fulvestrant 500 mg N=228		Anastrozole 1mg N=232	
	All Grades %	Grade 3 or 4 %	All Grades %	Grade 3 or 4 %
Alanine aminotransferase increased (ALT)	7	1	3	0
Aspartate aminotransferase increased (AST)	5	1	3	<1

1. In FALCON, post-baseline increases of ≥ 1 CTC grade in either AST, ALT, or alkaline phosphatase were observed in $>10\%$ of patients receiving Fulvestrant. Grade 3-4 increases were observed in 1%-3% of patients.

Comparison of Fulvestrant 250 mg and Anastrozole 1 mg in Combined Trials (Studies 0020 and 0021)

The most commonly reported adverse reactions in the Fulvestrant and anastrozole treatment groups were gastrointestinal symptoms (including nausea, vomiting, constipation, diarrhea, and abdominal pain), headache, back pain, vasodilatation (hot flashes), and pharyngitis.

Injection site reactions with mild transient pain and inflammation were seen with Fulvestrant and occurred in 7% of patients given the single 5 mL injection (Study 0020) and in 27% of patients given the 2 x 2.5 mL injections (Study 0021) in the two clinical trials that compared Fulvestrant 250 mg and anastrozole 1 mg.

Table 4 lists adverse reactions reported with an incidence of 5% or greater, regardless of assessed causality, from the two controlled clinical trials comparing the administration of Fulvestrant 250 mg intramuscularly once a month with anastrozole 1 mg orally once a day.

Table 4: Adverse Reactions in Studies 0020 and 0021 ($\geq 5\%$ from Combined Data)

Adverse Reactions	Fulvestrant 250 mg N=423 %	Anastrozole 1 mg N=423 %
Body as a Whole	68	68
Asthenia	23	27
Pain	19	20
Headache	15	17
Back Pain	14	13
Abdominal Pain	12	12
Injection Site Pain ¹	11	7
Pelvic Pain	10	9
Chest Pain	7	5
Flu Syndrome	7	6
Fever	6	6
Accidental Injury	5	6
Cardiovascular System	30	28
Vasodilatation	18	17
Digestive System	52	48
Nausea	26	25
Vomiting	13	12
Constipation	13	11
Diarrhea	12	13
Anorexia	9	11
Hemic and Lymphatic Systems	14	14
Anemia	5	5
Metabolic and Nutritional Disorders	18	18
Peripheral Edema	9	10
Musculoskeletal System	26	28
Bone Pain	16	14
Arthritis	3	6
Nervous System	34	34
Dizziness	7	7
Insomnia	7	9
Paresthesia	6	8
Depression	6	7
Anxiety	5	4
Respiratory System	39	34
Pharyngitis	16	12

Adverse Reactions	Fulvestrant 250 mg N=423 %	Anastrozole 1 mg N=423 %
Dyspnea	15	12
Cough Increased	10	10
Skin and Appendages	22	23
Rash	7	8
Sweating	5	5
Urogenital System	18	15
Urinary Tract Infection	6	4

1. Including more severe injection site related sciatica, neuralgia, neuropathic pain, and peripheral neuropathy. All patients on fulvestrant received injections, but only those anastrozole patients who were in Study 0021 received placebo injections.

Combination Therapy

Combination Therapy with Palbociclib (PALOMA-3)

The safety of Fulvestrant 500 mg plus palbociclib 125 mg/day versus Fulvestrant plus placebo was evaluated in PALOMA-3. The data described below reflect exposure to Fulvestrant plus palbociclib in 345 out of 517 patients with HR-positive, HER2-negative advanced or metastatic breast cancer who received at least 1 dose of treatment in PALOMA-3. The median duration of treatment for Fulvestrant plus palbociclib was 10.8 months while the median duration of treatment for Fulvestrant plus placebo arm was 4.8 months.

No dose reduction was allowed for Fulvestrant in PALOMA-3. Dose reductions of palbociclib due to an adverse reaction of any grade occurred in 36% of patients receiving Fulvestrant plus palbociclib.

Permanent discontinuation associated with an adverse reaction occurred in 19 of 345 (6%) patients receiving Fulvestrant plus palbociclib, and in 6 of 172 (3%) patients receiving Fulvestrant plus placebo. Adverse reactions leading to discontinuation for those patients receiving Fulvestrant plus palbociclib included fatigue (0.6%), infections (0.6%), and thrombocytopenia (0.6%).

The most common adverse reactions ($\geq 10\%$) of any grade reported in patients in the Fulvestrant plus palbociclib arm by descending frequency were neutropenia, leukopenia, infections, fatigue, nausea, anemia, stomatitis, diarrhea, thrombocytopenia, vomiting, alopecia, rash, decreased appetite, and pyrexia.

The most frequently reported Grade ≥ 3 adverse reactions ($\geq 5\%$) in patients receiving Fulvestrant plus palbociclib in descending frequency were neutropenia and leukopenia.

Adverse reactions ($\geq 10\%$) reported in patients who received Fulvestrant plus palbociclib or Fulvestrant plus placebo in PALOMA-3 are listed in Table 5, and laboratory abnormalities are listed in Table 6.

Table 5: Adverse Reactions (≥10%) in PALOMA-3

Adverse Reactions	Fulvestrant plus Palbociclib N=345			Fulvestrant plus Placebo N=172		
	All Grades %	Grade 3 %	Grade 4 %	All Grades %	Grade 3 %	Grade 4 %
Infections and Infestations						
Infections ¹	47 ²	3	1	31	3	0
Blood and Lymphatic System Disorders						
Neutropenia	83	55	11	4	1	0
Leukopenia	53	30	1	5	1	1
Anemia	30	4	0	13	2	0
Thrombocytopenia	23	2	1	0	0	0
Metabolism and Nutrition Disorders						
Decreased appetite	16	1	0	8	1	0
Gastrointestinal Disorders						
Nausea	34	0	0	28	1	0
Stomatitis ³	28	1	0	13	0	0
Diarrhea	24	0	0	19	1	0
Vomiting	19	1	0	15	1	0
Skin and Subcutaneous Tissue Disorders						
Alopecia	18 ⁴	N/A	N/A	6 ⁵	N/A	N/A
Rash ⁶	17	1	0	6	0	0
General Disorders and Administration Site Conditions						
Fatigue	41	2	0	29	1	0
Pyrexia	13	<1	0	5	0	0

Grading according to CTCAE v.4.0.

CTCAE=Common Terminology Criteria for Adverse Events; N=number of patients; N/A=not applicable.

1. Infections includes all reported preferred terms (PTs) that are part of the System Organ Class Infections and infestations.
2. Most common infections (≥1%) include: nasopharyngitis, upper respiratory infection, urinary tract infection, influenza, bronchitis, rhinitis, conjunctivitis, pneumonia, sinusitis, cystitis, oral herpes, respiratory tract infection, gastroenteritis, tooth infection, pharyngitis, eye infection, herpes simplex, paronychia.
3. Stomatitis includes: aphthous stomatitis, cheilitis, glossitis, glossodynia, mouth ulceration, mucosal inflammation, oral pain, oropharyngeal discomfort, oropharyngeal pain, stomatitis.
4. Grade 1 events – 17%; Grade 2 events – 1%.
5. Grade 1 events – 6%.
6. Rash includes: rash, rash maculo-papular, rash pruritic, rash erythematous, rash papular, dermatitis, dermatitis acneiform, toxic skin eruption.

Additional adverse reactions occurring at an overall incidence of <10.0% of patients receiving Fulvestrant plus palbociclib in PALOMA-3 included asthenia (7.5%), aspartate aminotransferase increased (7.5%), dysgeusia (6.7%), epistaxis (6.7%), lacrimation increased (6.4%), dry skin (6.1%), alanine aminotransferase increased (5.8%), vision blurred (5.8%), dry eye (3.8%), and febrile neutropenia (0.9%).

Table 6: Laboratory Abnormalities in PALOMA-3

Laboratory Parameters	Fulvestrant plus Palbociclib N=345			Fulvestrant plus Placebo N=172		
	All Grades %	Grade 3 %	Grade 4 %	All Grades %	Grade 3 %	Grade 4 %
WBC decreased	99	45	1	26	0	1
Neutrophils decreased	96	56	11	14	0	1
Anemia	78	3	0	40	2	0
Platelets decreased	62	2	1	10	0	0
Aspartate aminotransferase increased	43	4	0	48	4	0
Alanine aminotransferase increased	36	2	0	34	0	0

N=number of patients; WBC=white blood cells.

Combination Therapy with Abemaciclib (MONARCH 2)

The safety of Fulvestrant (500 mg) plus abemaciclib (150 mg twice daily) versus Fulvestrant plus placebo was evaluated in MONARCH 2. The data described below reflect exposure to Fulvestrant in 664 patients with HR-positive, HER2-negative advanced breast cancer who received at least one dose of Fulvestrant plus abemaciclib or placebo in MONARCH 2.

Median duration of treatment was 12 months for patients receiving Fulvestrant plus abemaciclib and 8 months for patients receiving Fulvestrant plus placebo.

Dose reductions due to an adverse reaction occurred in 43% of patients receiving Fulvestrant plus abemaciclib. Adverse reactions leading to dose reductions $\geq 5\%$ of patients were diarrhea and neutropenia. Abemaciclib dose reduction due to diarrhea of any grade occurred in 19% of patients receiving Fulvestrant plus abemaciclib compared to 0.4% of patients receiving Fulvestrant plus placebo. Abemaciclib dose reductions due to neutropenia of any grade occurred in 10% of patients receiving Fulvestrant plus abemaciclib compared to no patients receiving Fulvestrant plus placebo.

Permanent study treatment discontinuation due to an adverse event was reported in 9% of patients receiving Fulvestrant plus abemaciclib and in 3% of patients receiving Fulvestrant plus placebo. Adverse reactions leading to permanent discontinuation for patients receiving Fulvestrant plus abemaciclib were infection (2%), diarrhea (1%), hepatotoxicity (1%), fatigue (0.7%), nausea (0.2%), abdominal pain (0.2%), acute kidney injury (0.2%), and cerebral infarction (0.2%).

Deaths during treatment or during the 30-day follow up, regardless of causality, were reported in 18 cases (4%) of Fulvestrant plus abemaciclib treated patients versus 10 cases (5%) of Fulvestrant plus placebo treated patients. Causes of death for patients receiving Fulvestrant plus abemaciclib included: 7 (2%) patient deaths due to underlying disease, 4 (0.9%) due to sepsis, 2 (0.5%) due to pneumonitis, 2 (0.5%) due to hepatotoxicity, and one (0.2%) due to cerebral infarction.

The most common adverse reactions reported ($\geq 20\%$) in the Fulvestrant plus abemaciclib arm were diarrhea, fatigue, neutropenia, nausea, infections, abdominal pain, anemia, leukopenia, decreased appetite, vomiting, and headache (Table 7). The most frequently reported ($\geq 5\%$) Grade 3 or 4 adverse reactions were neutropenia, diarrhea, leukopenia, anemia, and infections.

Table 7: Adverse Reactions $\geq 10\%$ of Patients Receiving Fulvestrant Plus Abemaciclib and $\geq 2\%$ Higher Than Fulvestrant Plus Placebo in MONARCH 2

Adverse Reactions	Fulvestrant plus Abemaciclib N=441			Fulvestrant plus Placebo N=223		
	All Grades %	Grade 3 %	Grade 4 %	All Grades %	Grade 3 %	Grade 4 %
Gastrointestinal Disorders						
Diarrhea	86	13	0	25	<1	0
Nausea	45	3	0	23	1	0
Abdominal pain ¹	35	2	0	16	1	0
Vomiting	26	<1	0	10	2	0
Stomatitis	15	<1	0	10	0	0
Infections and Infestations						
Infections ²	43	5	<1	25	3	<1
Blood and Lymphatic System Disorders						
Neutropenia ³	46	24	3	4	1	<1
Anemia ⁴	29	7	<1	4	1	0
Leukopenia ⁵	28	9	<1	2	0	0
Thrombocytopenia ⁶	16	2	1	3	0	<1
General Disorders and Administration Site Conditions						
Fatigue ⁷	46	3	0	32	<1	0
Edema peripheral	12	0	0	7	0	0
Pyrexia	11	<1	<1	6	<1	0
Metabolism and Nutrition Disorders						
Decreased appetite	27	1	0	12	<1	0
Respiratory, Thoracic, and Mediastinal Disorders						
Cough	13	0	0	11	0	0
Skin and Subcutaneous Tissue Disorders						
Alopecia	16	0	0	2	0	0
Pruritus	13	0	0	6	0	0
Rash	11	1	0	4	0	0
Nervous System Disorders						
Headache	20	1	0	15	<1	0
Dysgeusia	18	0	0	3	0	0
Dizziness	12	1	0	6	0	0
Investigations						

Adverse Reactions	Fulvestrant plus Abemaciclib N=441			Fulvestrant plus Placebo N=223		
	All Grades %	Grade 3 %	Grade 4 %	All Grades %	Grade 3 %	Grade 4 %
Alanine aminotransferase increased	13	4	<1	5	2	0
Aspartate aminotransferase increased	12	2	0	7	3	0
Creatinine increased	12	<1	0	<1	0	0
Weight decreased	10	<1	0	2	<1	0

1. Includes abdominal pain, abdominal pain upper, abdominal pain lower, abdominal discomfort, abdominal tenderness.

2. Includes upper respiratory tract infection, urinary tract infection, lung infection, pharyngitis, conjunctivitis, sinusitis, vaginal infection, sepsis.

3. Includes neutropenia, neutrophil count decreased.

4. Includes anemia, hematocrit decreased, hemoglobin decreased, red blood cell count decreased.

5. Includes leukopenia, white blood cell count decreased.

6. Includes platelet count decreased, thrombocytopenia.

7. Includes asthenia, fatigue.

Additional adverse reactions in MONARCH 2 include venous thromboembolic events (deep vein thrombosis, pulmonary embolism, cerebral venous sinus thrombosis, subclavian vein thrombosis, axillary vein thrombosis, and DVT inferior vena cava), which were reported in 5% of patients treated with Fulvestrant plus abemaciclib as compared to 0.9% of patients treated with Fulvestrant plus placebo.

Table 8: Laboratory Abnormalities $\geq 10\%$ in Patients Receiving Fulvestrant Plus Abemaciclib and $\geq 2\%$ Higher Than Fulvestrant Plus Placebo in MONARCH 2

Laboratory Parameters	Fulvestrant plus Abemaciclib N=441			Fulvestrant plus Placebo N=223		
	All Grades %	Grade 3 %	Grade 4 %	All Grades %	Grade 3 %	Grade 4 %
Creatinine increased	98	1	0	74	0	0
White blood cell decreased	90	23	<1	33	<1	0
Neutrophil count decreased	87	29	4	30	4	<1
Anemia	84	3	0	33	<1	0
Lymphocyte count decreased	63	12	<1	32	2	0
Platelet count decreased	53	<1	1	15	0	0
Alanine aminotransferase increased	41	4	<1	32	1	0
Aspartate aminotransferase increased	37	4	0	25	4	<1

Combination Therapy with Ribociclib (MONALEESA-3)

The safety of Fulvestrant 500 mg plus ribociclib 600 mg versus Fulvestrant plus placebo was evaluated in MONALEESA-3. The data described below reflect exposure to Fulvestrant plus ribociclib in 483 out of 724 postmenopausal patients with HR-positive, HER2-negative advanced or metastatic breast cancer for initial endocrine based therapy or after disease progression on endocrine therapy who received at least one dose of Fulvestrant plus ribociclib or placebo in MONALEESA-3. Median duration of treatment was 15.8 months for Fulvestrant plus ribociclib and 12 months for Fulvestrant plus placebo.

Dose reductions due to adverse reactions occurred in 32% of patients receiving Fulvestrant plus ribociclib and in 3% of patients receiving Fulvestrant plus placebo. Among patients receiving Fulvestrant plus ribociclib, 8% were reported to have permanently discontinued both Fulvestrant plus ribociclib, and 9% were reported to have discontinued ribociclib alone due to ARs. Among patients receiving Fulvestrant plus placebo, 4% were reported to have permanently discontinued both Fulvestrant and placebo and 2% were reported to have discontinued placebo alone due to ARs.

Adverse reactions leading to treatment discontinuation of Fulvestrant plus ribociclib (as compared to Fulvestrant plus placebo) were ALT increased (5% vs. 0%), AST increased (3% vs. 0.6%), and vomiting (1% vs. 0%).

The most common adverse reactions (reported at a frequency $\geq 20\%$ on the Fulvestrant plus ribociclib arm and $\geq 2\%$ higher than Fulvestrant plus placebo) were neutropenia, infections, leukopenia, cough, nausea, diarrhea, vomiting, constipation, pruritus, and rash. The most frequently reported Grade ≥ 3 adverse reactions (reported at a frequency $\geq 5\%$) in patients receiving Fulvestrant plus ribociclib in descending frequency were neutropenia, leukopenia, infections, and abnormal liver function tests.

Adverse reactions and laboratory abnormalities occurring in patients in MONALEESA-3 are listed in Table 9 and Table 10, respectively.

Table 9: Adverse Reactions Occurring in $\geq 10\%$ and $\geq 2\%$ higher than Fulvestrant plus Placebo Arm in MONALEESA-3 (All Grades)

Adverse Reactions	Fulvestrant plus Ribociclib N=483			Fulvestrant plus Placebo N=241		
	All Grades %	Grade 3 %	Grade 4 %	All Grades %	Grade 3 %	Grade 4 %
Infections and Infestations						
Infections ¹	42	5	0	30	2	0
Blood and Lymphatic System Disorders						
Neutropenia	69	46	7	2	0	0
Leukopenia	27	12	<1	<1	0	0
Anemia	17	3	0	5	2	0
Metabolism and Nutrition Disorders						
Decreased appetite	16	<1	0	13	0	0
Nervous System Disorders						
Dizziness	13	<1	0	8	0	0
Respiratory, Thoracic, and Mediastinal Disorders						

Adverse Reactions	Fulvestrant plus Ribociclib N=483			Fulvestrant plus Placebo N=241		
	All Grades %	Grade 3 %	Grade 4 %	All Grades %	Grade 3 %	Grade 4 %
Cough	22	0	0	15	0	0
Dyspnea	15	1	<1	12	2	0
Gastrointestinal Disorders						
Nausea	45	1	0	28	<1	0
Diarrhea	29	<1	0	20	<1	0
Vomiting	27	1	0	13	0	0
Constipation	25	<1	0	12	0	0
Abdominal pain	17	1	0	13	<1	0
Skin and Subcutaneous Tissue Disorders						
Alopecia	19	0	0	5	0	0
Pruritus	20	<1	0	7	0	0
Rash	23	<1	0	7	0	0
General Disorders and Administration Site Conditions						
Edema peripheral	15	0	0	7	0	0
Pyrexia	11	<1	0	7	0	0
Investigations						
Alanine aminotransferase increased	15	7	2	5	<1	0
Aspartate aminotransferase increased	13	5	1	5	<1	0

Grading according to CTCAE 4.03.

CTCAE=Common Terminology Criteria for Adverse Events; N=number of patients

1. Infections; urinary tract infections; respiratory tract infections; gastroenteritis; sepsis (<1%).

Additional adverse reactions in MONALEESA-3 for patients receiving Fulvestrant plus ribociclib included asthenia (14%), dyspepsia (10%), thrombocytopenia (9%), dry skin (8%), dysgeusia (7%), electrocardiogram QT prolonged (6%), dry mouth (5%), vertigo (5%), dry eye (5%), lacrimation increased (4%), erythema (4%), hypocalcemia (4%), blood bilirubin increased (1%), and syncope (1%).

Table 10: Laboratory Abnormalities Occurring in $\geq 10\%$ of Patients in MONALEESA-3

Laboratory parameters	Fulvestrant plus Ribociclib N=483			Fulvestrant plus Placebo N=241		
	All Grades %	Grade 3 %	Grade 4 %	All Grades %	Grade 3 %	Grade 4 %
Hematology						
Leukocyte count decreased	95	25	<1	26	<1	0
Neutrophil count decreased	92	46	7	21	<1	0
Hemoglobin decreased	60	4	0	35	3	0
Lymphocyte count decreased	69	14	1	35	4	<1
Platelet count decreased	33	<1	1	11	0	0
Chemistry						

Creatinine increased	65	<1	<1	33	<1	0
Gamma-glutamyl transferase increased	52	6	1	49	8	2
Aspartate aminotransferase increased	49	5	2	43	3	0
Alanine aminotransferase increased	44	8	3	37	2	0
Glucose serum decreased	23	0	0	18	0	0
Phosphorous decreased	18	5	0	8	<1	0
Albumin decreased	12	0	0	8	0	0

6.2 Postmarketing Experience

The following adverse reactions have been identified during post-approval use of Fulvestrant injection. Because these reactions are reported voluntarily from a population of uncertain size, it is not always possible to reliably estimate their frequency or establish a causal relationship to drug exposure.

For Fulvestrant injection 250 mg, other adverse reactions reported as drug-related and seen infrequently (<1%) include thromboembolic phenomena, myalgia, vertigo, leukopenia, and hypersensitivity reactions, including angioedema and urticaria.

Vaginal bleeding has been reported infrequently (<1%), mainly in patients during the first 6 weeks after changing from existing hormonal therapy to treatment with Fulvestrant injection. If bleeding persists, further evaluation should be considered.

Elevation of bilirubin, elevation of gamma GT, hepatitis, and liver failure have been reported infrequently (<1%).

7 DRUG INTERACTIONS

There are no known drug-drug interactions. Although, fulvestrant is metabolized by CYP 3A4 *in vitro*, drug interactions studies with ketoconazole or rifampin did not alter fulvestrant pharmacokinetics. Dose adjustment is not needed in patients co-prescribed CYP 3A4 inhibitors or inducers [see *Clinical Pharmacology (12.3)*].

8 USE IN SPECIFIC POPULATIONS

8.1 Pregnancy

Risk Summary

Based on findings from animal studies and its mechanism of action, Fulvestrant injection can cause fetal harm when administered to a pregnant woman [see *Clinical Pharmacology (12.1)*]. There are no available data in pregnant women to inform the drug-associated risk. In animal reproduction studies, administration of fulvestrant to pregnant rats and rabbits during organogenesis caused embryo-fetal toxicity, including skeletal malformations and fetal loss, at daily doses that were 6% and 30% of the maximum recommended human dose based on mg/m², respectively [see *Data*]. Advise pregnant women of the potential risk to a fetus.

The estimated background risk of major birth defects and miscarriage for the indicated population is unknown. In the U.S. general population, the estimated background risk of major birth defects and miscarriage in clinically recognized pregnancies is 2-4% and 15-20%, respectively.

Data

Animal Data

Administration of fulvestrant to rats prior to and up to implantation caused embryonic loss at daily doses that were 0.6% of the daily maximum recommended human dose based on mg/m^2 . When fulvestrant was administered to pregnant rats during the period of organogenesis, intramuscular doses $\geq 0.1 \text{ mg}/\text{kg}/\text{day}$ (6% of the human recommended dose based on mg/m^2) caused effects on embryo-fetal development consistent with its antiestrogenic activity. Fulvestrant caused an increased incidence of fetal abnormalities in rats (tarsal flexure of the hind paw at $2 \text{ mg}/\text{kg}/\text{day}$; equivalent to the human dose based on mg/m^2) and non-ossification of the odontoid and ventral tubercle of the first cervical vertebra at doses $\geq 0.1 \text{ mg}/\text{kg}/\text{day}$. Fulvestrant administered at $2 \text{ mg}/\text{kg}/\text{day}$ caused fetal loss.

When administered to pregnant rabbits during the period of organogenesis, fulvestrant caused pregnancy loss at an intramuscular dose of $1 \text{ mg}/\text{kg}/\text{day}$ (equivalent to the human dose based on mg/m^2). Further, at $0.25 \text{ mg}/\text{kg}/\text{day}$ (30% the human dose based on mg/m^2), fulvestrant caused increases in placental weight and post-implantation loss in rabbits. Fulvestrant was associated with an increased incidence of fetal variations in rabbits (backwards displacement of the pelvic girdle, and 27 pre-sacral vertebrae at $0.25 \text{ mg}/\text{kg}/\text{day}$; 30% the human dose based on mg/m^2) when administered during the period of organogenesis.

8.2 Lactation

Risk Summary

There is no information regarding the presence of fulvestrant in human milk, nor of its effects on milk production or breastfed infant. Fulvestrant can be detected in rat milk [*see Data*]. Because of the potential for serious adverse reactions in breastfed infants from Fulvestrant injection, advise a lactating woman not to breastfeed during treatment with Fulvestrant injection and for one year after the final dose.

Data

Levels of fulvestrant were approximately 12-fold higher in milk than in plasma after exposure of lactating rats to a dose of $2 \text{ mg}/\text{kg}$. Drug exposure in rodent pups from fulvestrant-treated lactating dams was estimated as 10% of the administered dose. In a study in rats of fulvestrant at $10 \text{ mg}/\text{kg}$ given twice or $15 \text{ mg}/\text{kg}$ given once (less than the recommended human dose based on mg/m^2) during lactation, offspring survival was slightly reduced.

8.3 Females and Males of Reproductive Potential

Pregnancy Testing

Pregnancy testing is recommended for females of reproductive potential within seven days prior to initiating Fulvestrant injection.

Contraception

Females

Fulvestrant injection can cause fetal harm when administered to a pregnant woman [*see Use in Specific Populations (8.1)*]. Advise females of reproductive potential to use effective contraception during treatment and for one year after the last dose.

Infertility

Based on animal studies, Fulvestrant injection may impair fertility in females and males of reproductive potential. The effects of fulvestrant on fertility were reversible in female rats [*see Nonclinical Toxicology (13.1)*].

8.4 Pediatric Use

Safety and effectiveness in pediatric patients have not been established. A multi-center, single-arm, open-label, study of fulvestrant was conducted in 30 girls with McCune-Albright Syndrome (MAS) associated with Progressive Precocious Puberty (PPP). The median age at informed consent was 6 years old (range: 1 to 8).

The first 10 patients initially received fulvestrant 2 mg/kg. Based on PK data from the first 6 patients, all 10 patients receiving 2 mg/kg were escalated to a dose of 4 mg/kg and all other patients received 4 mg/kg from study entry.

Baseline measurements for vaginal bleeding days, bone age, growth velocity, and Tanner staging for at least 6 months prior to study entry were provided retrospectively by the parent, guardian, or local consultant. All measurements during the study period were collected prospectively. Patients' baseline characteristics included the following: a mean \pm SD chronological age of 5.9 ± 1.8 years; a mean rate of bone age advancement (change in bone age in years divided by change in chronological age in years) of 2.0 ± 1.03 ; and a mean growth velocity z-score of 2.4 ± 3.26 .

Twenty-nine of 30 patients completed the 12-month study period. The following results were observed: 35% (95% CI: 16%, 57%) of the 23 patients with baseline vaginal bleeding experienced a complete cessation of vaginal bleeding on-treatment (month 0 to 12); a reduction in the rate of bone age advancement during the 12-month study period compared to baseline (mean change = -0.9 [95% CI: $-1.4, -0.4$]); and a reduction in mean growth velocity Z-score on-treatment compared to baseline (mean change = -1.1 [95% CI: $-2.7, 0.4$]). There were no clinically meaningful changes in median Tanner stage (breast or pubic), mean uterine volume, or mean ovarian volume, or predicted adult height (PAH) on-treatment compared to baseline. The effect of Fulvestrant injection on bone mineral density in children has not been studied and is not known.

Eight patients (27%) experienced adverse reactions that were considered possibly related to Fulvestrant injection. These included injection site reactions (inflammation, pain, hematoma, pruritus, rash), abdominal pain, contusion, tachycardia, hot flash, extremity pain, and vomiting. Nine (30%) patients reported an SAE, none of which were considered related to Fulvestrant injection. No patients discontinued study treatment due to an AE and no patients died.

Pharmacokinetics

The pharmacokinetics of fulvestrant was characterized using a population pharmacokinetic analysis with sparse samples per patient obtained from 30 female pediatric patients aged 1 to 8 years with PPP associated with MAS. Pharmacokinetic data from 294 postmenopausal women with breast cancer who received 125 or 250 mg monthly dosing regimen were also included in the analysis.

In these pediatric patients receiving 4 mg/kg monthly intramuscular dose of fulvestrant, the geometric mean (SD) CL/F was 444 (165) mL/min which was 32% lower than adults. The geometric mean (SD) steady state trough concentration ($C_{\min,ss}$) and AUC_{ss} was 4.19 (0.87) ng/mL and 3680 (1020) ng*hr/mL, respectively.

8.5 Geriatric Use

For Fulvestrant injection 250 mg, when tumor response was considered by age, objective responses were seen in 22% and 24% of patients under 65 years of age and in 11% and 16% of patients 65 years of age and older, who were treated with Fulvestrant injection in Study 0021 and Study 0020, respectively.

8.6 Hepatic Impairment

Fulvestrant injection is metabolized primarily in the liver.

The pharmacokinetics of fulvestrant were evaluated after a single dose of 100 mg in subjects with mild and moderate hepatic impairment and normal hepatic function (n = 7 subjects/group), using a shorter-acting intramuscular injection formulation. Subjects with mild hepatic impairment (Child-Pugh class A) had comparable mean AUC and clearance values to those with normal hepatic function. In subjects with moderate hepatic impairment (Child-Pugh class B), the average AUC of fulvestrant increased by 70% compared to patients with normal hepatic function. AUC was positively correlated with total bilirubin concentration (p = 0.012). Fulvestrant injection has not been studied in patients with severe hepatic impairment (Child-Pugh class C).

A dose of Fulvestrant injection 250 mg is recommended in patients with moderate hepatic impairment (Child-Pugh class B) [*see Dosage and Administration (2.2) and Warnings and Precautions (5.2)*].

8.7 Renal Impairment

Negligible amounts of fulvestrant are eliminated in urine; therefore, a study in patients with renal impairment was not conducted. In the advanced breast cancer trials, fulvestrant concentrations in

women with estimated creatinine clearance as low as 30 mL/min were similar to women with normal creatinine.

10 OVERDOSAGE

Human experience of overdose with Fulvestrant injection is limited. There are isolated reports of overdose with Fulvestrant injection in humans. No adverse reactions were seen in healthy male and female volunteers who received intravenous fulvestrant, which resulted in peak plasma concentrations at the end of the infusion, that were approximately 10 to 15 times those seen after intramuscular injection. The potential toxicity of fulvestrant at these or higher concentrations in cancer patients who may have additional comorbidities is unknown. There is no specific treatment in the event of fulvestrant overdose, and symptoms of overdose are not established. In the event of an overdose, healthcare practitioners should follow general supportive measures and should treat symptomatically.

11 DESCRIPTION

Fulvestrant injection for intramuscular administration is an estrogen receptor antagonist. The chemical name is 7- α -[9-(4,4,5,5,5-penta fluoropentylsulphonyl) nonyl]estra-1,3,5-(10)-triene-3,17- β -diol. The molecular formula is $C_{32}H_{47}F_5O_3S$ and its structural formula is:

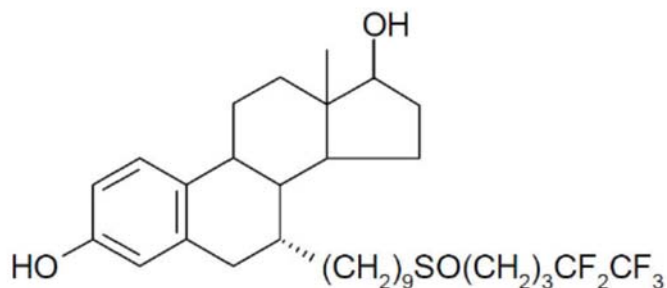

Fulvestrant is a white powder with a molecular weight of 606.77. The solution for injection is a clear, colorless to yellow, viscous liquid.

Each injection contains as inactive ingredients: 10% w/v Alcohol, USNF (equivalent to 12.2549% v/v Alcohol, USNF), 10% w/v Benzyl Alcohol, NF, and 15% w/v Benzyl Benzoate, USP, as co-solvents, and made up to 100% w/v with Castor Oil, USP as a co-solvent and release rate modifier.

12 CLINICAL PHARMACOLOGY

12.1 Mechanism of Action

Many breast cancers have estrogen receptors (ER) and the growth of these tumors can be stimulated by estrogen. Fulvestrant is an estrogen receptor antagonist that binds to the estrogen receptor in a competitive manner with affinity comparable to that of estradiol and downregulates the ER protein in human breast cancer cells.

In vitro studies demonstrated that fulvestrant is a reversible inhibitor of the growth of tamoxifen-resistant, as well as estrogen-sensitive human breast cancer (MCF-7) cell lines. In *in vivo* tumor studies, fulvestrant delayed the establishment of tumors from xenografts of human breast cancer MCF-7 cells in nude mice. Fulvestrant inhibited the growth of established MCF-7 xenografts and of tamoxifen-resistant breast tumor xenografts.

Fulvestrant showed no agonist-type effects in *in vivo* uterotrophic assays in immature or ovariectomized mice and rats. In *in vivo* studies in immature rats and ovariectomized monkeys, fulvestrant blocked the uterotrophic action of estradiol. In postmenopausal women, the absence of changes in plasma concentrations of FSH and LH in response to fulvestrant treatment (250 mg monthly) suggests no peripheral steroidal effects.

12.2 Pharmacodynamics

In a clinical study in postmenopausal women with primary breast cancer treated with single doses of Fulvestrant injection 15-22 days prior to surgery, there was evidence of increasing down-regulation of ER with increasing dose. This was associated with a dose-related decrease in the expression of the progesterone receptor, an estrogen-regulated protein. These effects on the ER pathway were also associated with a decrease in Ki67 labeling index, a marker of cell proliferation.

12.3 Pharmacokinetics

Absorption:

The single dose and multiple dose PK parameters for the 500 mg dosing regimen with an additional dose (AD) at Day 15 are reported in Table 11. The additional dose of Fulvestrant injection given two weeks after the initial dose allows for steady state concentrations to be reached within the first month of dosing.

Table 11: Summary of Fulvestrant Pharmacokinetic Parameters [gMean (CV%)] in Postmenopausal Advanced Breast Cancer Patients after Intramuscular Administration 500 mg + AD Dosing Regimen

		C_{max} (ng/mL)	C_{min} (ng/mL)	AUC (ng.hr/mL)
500 mg + AD ¹	Single dose	25.1 (35.3)	16.3 (25.9)	11400 (33.4)
	Multiple dose steady state ²	28.0 (27.9)	12.2 (21.7)	13100 (23.4)

1. Additional 500 mg dose given on Day 15

2. Month 3

Distribution:

The apparent volume of distribution at steady state is approximately 3 to 5 L/kg. This suggests that distribution is largely extravascular. Fulvestrant is highly (99%) bound to plasma proteins; VLDL, LDL, and HDL lipoprotein fractions appear to be the major binding components. The role of sex hormone-binding globulin, if any, could not be determined.

Metabolism:

Biotransformation and disposition of fulvestrant in humans have been determined following intramuscular and intravenous administration of ¹⁴C-labeled fulvestrant. Metabolism of fulvestrant appears to involve combinations of a number of possible biotransformation pathways analogous to those of endogenous steroids, including oxidation, aromatic hydroxylation, conjugation with glucuronic acid and/or sulphate at the 2, 3, and 17 positions of the steroid nucleus, and oxidation of the side chain sulphoxide. Identified metabolites are either less active or exhibit similar activity to fulvestrant in antiestrogen models.

Studies using human liver preparations and recombinant human enzymes indicate that cytochrome P-450 3A4 (CYP 3A4) is the only P-450 isoenzyme involved in the oxidation of fulvestrant; however, the relative contribution of P-450 and non-P-450 routes *in vivo* is unknown.

Excretion:

Fulvestrant was rapidly cleared by the hepatobiliary route with excretion primarily via the feces (approximately 90%). Renal elimination was negligible (less than 1%). After an intramuscular injection of 250 mg, the clearance (Mean ± SD) was 690 ± 226 mL/min with an apparent half-life about 40 days.

Special Populations:**Geriatric:**

In patients with breast cancer, there was no difference in fulvestrant pharmacokinetic profile related to age (range 33 to 89 years).

Gender:

Following administration of a single intravenous dose, there were no pharmacokinetic differences between men and women or between premenopausal and postmenopausal women. Similarly, there were no differences between men and postmenopausal women after intramuscular administration.

Race:

In the advanced breast cancer treatment trials, the potential for pharmacokinetic differences due to race have been evaluated in 294 women including 87.4% Caucasian, 7.8% Black, and 4.4% Hispanic. No differences in fulvestrant plasma pharmacokinetics were observed among these groups. In a separate trial, pharmacokinetic data from postmenopausal ethnic Japanese women were similar to those obtained in non-Japanese patients.

Drug-Drug Interactions:

There are no known drug-drug interactions. Fulvestrant does not significantly inhibit any of the major CYP isoenzymes, including CYP 1A2, 2C9, 2C19, 2D6, and 3A4 *in vitro*, and studies of co-administration of fulvestrant with midazolam indicate that therapeutic doses of fulvestrant have no inhibitory effects on CYP 3A4 or alter blood levels of drug metabolized by that enzyme. Although fulvestrant is partly metabolized by CYP 3A4, a clinical study with rifampin, an

inducer of CYP 3A4, showed no effect on the pharmacokinetics of fulvestrant. Also, results from a healthy volunteer study with ketoconazole, a potent inhibitor of CYP 3A4, indicated that ketoconazole had no effect on the pharmacokinetics of fulvestrant and dosage adjustment is not necessary in patients co-prescribed CYP 3A4 inhibitors or inducers [see *Drug Interactions (7)*]. Data from a clinical trial in patients with breast cancer showed that there was no clinically relevant drug interaction when fulvestrant is co-administered with palbociclib, abemaciclib or ribociclib.

13 NONCLINICAL TOXICOLOGY

13.1 Carcinogenesis, Mutagenesis, Impairment of Fertility

Two-year carcinogenesis studies were conducted in rats and mice. Positive findings were observed in both species. Rats were treated at intramuscular doses of 15 mg/kg/30 days, 10 mg/rat/30 days, and 10 mg/rat/15 days.

These doses correspond to 0.9-, 1.5-, and 3-fold (in females) and 0.8-, 0.8-, and 2-fold (in males) the systemic exposure [AUC_{0-30 days}] achieved in women receiving the recommended dose of 500 mg/month. An increased incidence of benign ovarian granulosa cell tumors and testicular Leydig cell tumors was evident, in females dosed at 10 mg/rat/15 days and males dosed at 15 mg/rat/30 days, respectively. Mice were treated at oral doses of 0, 20, 150, and 500 mg/kg/day. These doses correspond to 0-, 0.8-, 8.4-, and 18-fold (in females) and 0.8-, 7.1-, and 11.9- fold (in males), the systemic exposure (AUC_{0-30 days}) achieved in women receiving the recommended dose of 500 mg/month. There was an increased incidence of sex cord stromal tumors (both benign and malignant) in the ovary of mice at doses of 150 and 500 mg/kg/day. Induction of such tumors is consistent with the pharmacology-related endocrine feedback alterations in gonadotropin levels caused by an antiestrogen.

Fulvestrant was not mutagenic or clastogenic in multiple *in vitro* tests with and without the addition of a mammalian liver metabolic activation factor (bacterial mutation assay in strains of *Salmonella typhimurium* and *Escherichia coli*, *in vitro* cytogenetics study in human lymphocytes, mammalian cell mutation assay in mouse lymphoma cells, and *in vivo* micronucleus test in rat).

In female rats, fulvestrant administered at doses ≥ 0.01 mg/kg/day (0.6% the human recommended dose based on body surface area [BSA in mg/m^2]), for 2 weeks prior to and for 1 week following mating, caused a reduction in fertility and embryonic survival. No adverse effects on female fertility and embryonic survival were evident in female animals dosed at 0.001 mg/kg/day (0.06% the human dose based on BSA in mg/m^2). Restoration of female fertility to values similar to controls was evident following a 29-day withdrawal period after dosing at 2 mg/kg/day (equivalent to the human dose based on BSA in mg/m^2). The effects of fulvestrant on the fertility of female rats appear to be consistent with its antiestrogenic activity. The potential effects of fulvestrant on the fertility of male animals were not studied, but in a 6-month toxicology study, male rats treated with intramuscular doses of 15 mg/kg/30 days, 10 mg/rat/30 days, or 10 mg/rat/15 days fulvestrant showed a loss of spermatozoa from the seminiferous tubules, seminiferous tubular atrophy, and degenerative changes in the epididymides. Changes in the testes and epididymides had not recovered 20 weeks after cessation of dosing. These

fulvestrant doses correspond to 1.3-, 1.2-, and 3.5-fold the systemic exposure [AUC_{0-30 days}] achieved in women receiving the recommended dose of 500 mg/month.

14 CLINICAL STUDIES

The efficacy of Fulvestrant 500 mg versus Fulvestrant 250 mg was compared in CONFIRM. The efficacy of Fulvestrant 250 mg was compared to 1 mg anastrozole in Studies 0020 and 0021. The efficacy of Fulvestrant 500 mg was compared to 1 mg anastrozole in FALCON. The efficacy of Fulvestrant 500 mg in combination with palbociclib 125 mg was compared to Fulvestrant 500 mg plus placebo in PALOMA-3. The efficacy of Fulvestrant 500 mg in combination with abemaciclib 150 mg was compared to Fulvestrant 500mg plus placebo in MONARCH 2. The efficacy of Fulvestrant 500 mg in combination with ribociclib 600 mg was compared to Fulvestrant 500 mg plus placebo in MONALEESA-3.

Monotherapy

Comparison of Fulvestrant 500 mg and Fulvestrant 250 mg (CONFIRM)

A randomized, double-blind, controlled clinical trial (CONFIRM, NCT00099437) was completed in 736 postmenopausal women with advanced breast cancer who had disease recurrence on or after adjuvant endocrine therapy or progression following endocrine therapy for advanced disease. This trial compared the efficacy and safety of Fulvestrant 500 mg (n=362) with Fulvestrant 250 mg (n=374).

Fulvestrant 500 mg was administered as two 5 mL injections each containing Fulvestrant 250 mg/5mL, one in each buttock, on Days 1, 15, 29, and every 28 (+/-3) days thereafter. Fulvestrant 250 mg was administered as two 5 mL injections (one containing Fulvestrant 250 mg/5mL injection plus one placebo injection), one in each buttock, on Days 1, 15 (2 placebo injections only), 29, and every 28 (+/-3) days thereafter.

The median age of study participants was 61 years. All patients had ER+ advanced breast cancer. Approximately 30% of subjects had no measurable disease. Approximately 55% of patients had visceral disease.

Results of CONFIRM are summarized in Table 12. The efficacy of Fulvestrant 500 mg was compared to that of Fulvestrant 250 mg. Figure 6 shows a Kaplan-Meier plot of the Progression Free Survival (PFS) data after a minimum follow-up duration of 18 months demonstrating statistically significant superiority of Fulvestrant 500 mg vs. Fulvestrant 250 mg. In the initial Overall Survival (OS) analysis after a minimum follow-up duration of 18 months, there was no statistically significant difference in OS between the two treatment groups. After a minimum follow-up duration of 50 months, an updated OS analysis was performed. Figure 7 shows a Kaplan-Meier plot of the updated OS data.

Table 12: Efficacy Results in CONFIRM (Intent-To-Treat (ITT) Population)

Endpoint	Fulvestrant 500 mg (N=362)	Fulvestrant 250 mg (N=374)
PFS¹ Median (months)	6.5	5.4
Hazard Ratio ² (95% CI ³)	0.80 (0.68-0.94)	
p-value	0.006	
OS⁴Updated Analysis⁵ (% patients who died)	261 (72.1%)	293 (78.3%)
Median OS (months)	26.4	22.3
Hazard Ratio ² (95% CI ³) ⁶	0.81 (0.69-0.96)	
ORR⁷ (95% CI ³)	13.8% (9.7%, 18.8%) (33/240)	14.6% (10.5%, 19.4%) (38/261)

1. PFS (Progression Free Survival) = the time between randomization and the earliest of progression or death from any cause. Minimum follow-up duration of 18 months.

2. Hazard Ratio <1 favors Fulvestrant 500 mg.

3. CI=Confidence Interval

4. OS=Overall Survival

5. Minimum follow up duration of 50 months.

6. Not statistically significant as no adjustments were made for multiplicity.

7. ORR (Objective Response Rate), as defined as number (%) of patients with complete response or partial response, was analyzed in the evaluable patients with measurable disease at baseline (fulvestrant 500 mg N=240; fulvestrant 250 mg N=261). Minimum follow-up duration of 18 months.

Figure 6 Kaplan-Meier PFS: CONFIRM ITT Population

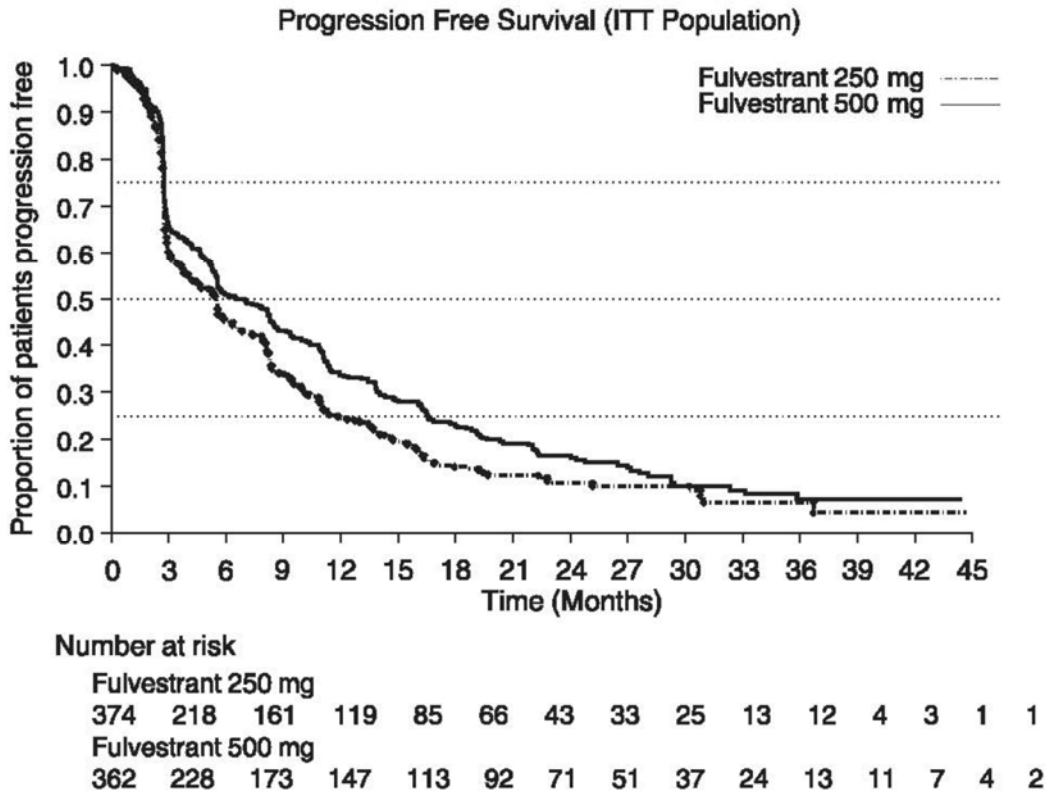
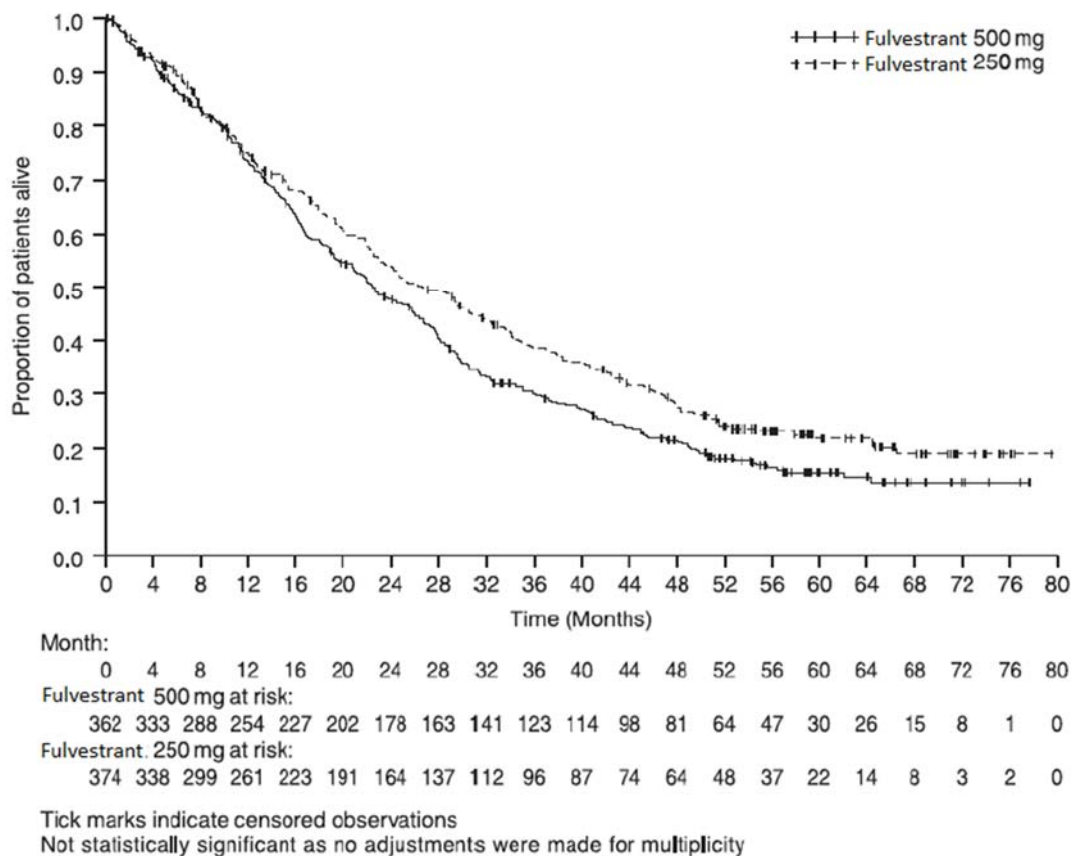

Figure 7 Kaplan-Meier OS (Minimum Follow-up Duration of 50 Months): CONFIRM ITT Population



Comparison of Fulvestrant 500 mg and Anastrozole 1 mg (FALCON)

A randomized, double-blind, double-dummy, multi-center study (FALCON, NCT01602380) of Fulvestrant 500 mg versus anastrozole 1 mg was conducted in postmenopausal women with ER-positive and/or PgR-positive, HER2-negative locally advanced or metastatic breast cancer who had not previously been treated with any hormonal therapy. A total of 462 patients were randomized 1:1 to receive administration of Fulvestrant 500 mg as an intramuscular injection on Days 1, 15, 29, and every 28 (+/-3) days thereafter or daily administration of 1 mg of anastrozole orally. This study compared the efficacy and safety of Fulvestrant 500 mg and anastrozole 1 mg.

Randomization was stratified by disease setting (locally advanced or metastatic), use of prior chemotherapy for advanced disease, and presence or absence of measurable disease.

The major efficacy outcome measure of the study was investigator-assessed progression-free survival (PFS) evaluated according to RECIST v.1.1 (Response Evaluation Criteria in Solid Tumors). Key secondary efficacy outcome measures included overall survival (OS), objective response rate (ORR), and duration of response (DoR).

Patients enrolled in this study had a median age of 63 years (range 36-90). The majority of patients (87%) had metastatic disease at baseline. Fifty-five percent (55%) of patients had

visceral metastasis at baseline. A total of 17% of patients had received one prior chemotherapy regimen for advanced disease; 84% of patients had measurable disease. Sites of metastases were as follows: musculoskeletal 59%, lymph nodes 50%, respiratory 40%, liver (including gall bladder) 18%.

The efficacy results of FALCON are presented in Table 13 and Figure 8.

Table 13: Efficacy Results in FALCON (Investigator Assessment, ITT Population)

	Fulvestrant 500 mg N=230	Anastrozole 1 mg N=232
Progression-Free Survival		
Number of PFS Events (%)	143 (62.2%)	166 (71.6%)
Median PFS (months)	16.6	13.8
PFS Hazard Ratio (95% CI)	0.797 (0.637 - 0.999)	
p-value	0.049	
Overall Survival¹		
Number of OS Events	67 (29.1%)	75 (32.3%)
Median OS (months)	NR	NR
OS Hazard Ratio (95% CI)	0.874 (0.629 – 1.216)	
Objective Response for Patients with Measurable Disease		
	N=193	N=196
Objective Response Rate (%; 95% CI)	46.1% (38.9%, 53.4%)	44.9% (37.8%, 52.1%)
Median DoR (months)	20.0	13.2

NR: Not reached

¹. Interim OS analysis with 61% of total number of events required for the final OS analysis.

Figure 8 Kaplan-Meier Plot of Progression-Free Survival (Investigator Assessment, ITT Population) – FALCON

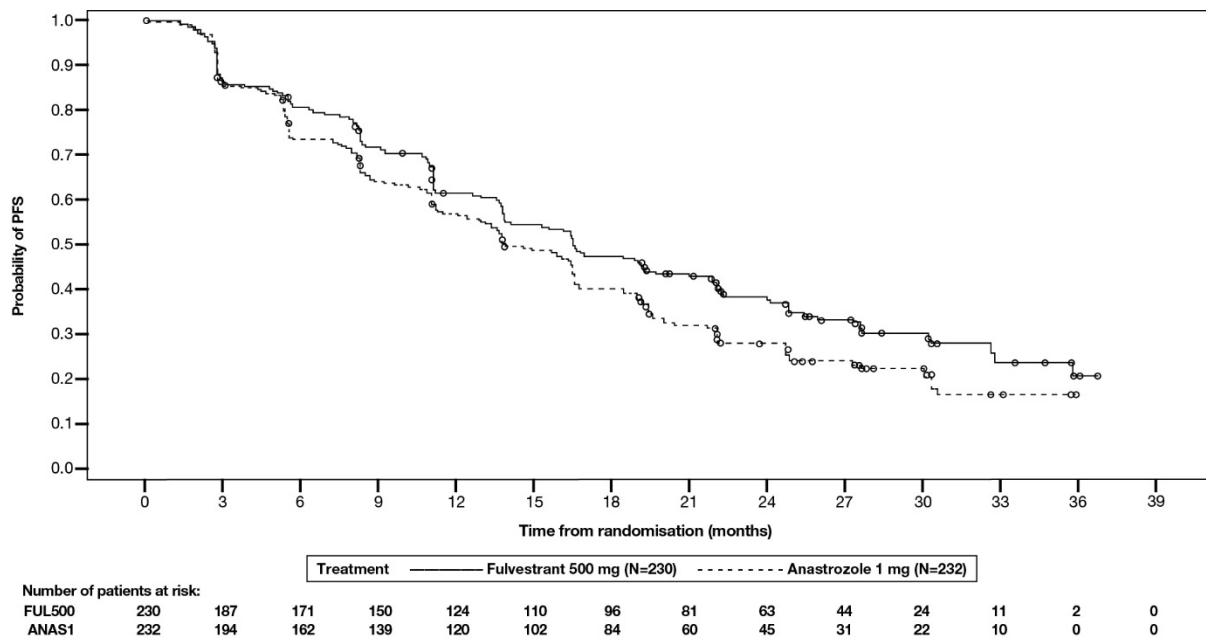

Comparison of Fulvestrant 250 mg and Anastrozole 1 mg in Combined Data (Studies 0020 and 0021)

Efficacy of Fulvestrant was established by comparison to the selective aromatase inhibitor anastrozole in two randomized, controlled clinical trials (one conducted in North America, Study 0021, NCT00635713; the other predominantly in Europe, Study 0020) in postmenopausal women with locally advanced or metastatic breast cancer. All patients had progressed after previous therapy with an antiestrogen or progestin for breast cancer in the adjuvant or advanced disease setting.

The median age of study participants was 64 years. 81.6% of patients had ER+ and/or PgR+ tumors. Patients with ER-/PgR- or unknown tumors were required to have demonstrated a prior response to endocrine therapy. Sites of metastases occurred as follows: visceral only 18.2%; viscera – liver involvement 23.0%; lung involvement 28.1%; bone only 19.7%; soft tissue only 5.2%; skin and soft tissue 18.7%.

In both trials, eligible patients with measurable and/or evaluable disease were randomized to receive either Fulvestrant 250 mg intramuscularly once a month (28 days \pm 3 days) or anastrozole 1 mg orally once a day. All patients were assessed monthly for the first three months and every three months thereafter. Study 0021 was a double-blind, randomized trial in 400 postmenopausal women. Study 0020 was an open-label, randomized trial conducted in 451 postmenopausal women. Patients on the Fulvestrant arm of Study 0021 received two separate injections (2 x 2.5 mL), whereas Fulvestrant patients received a single injection (1 x 5 mL) in Study 0020. In both trials, patients were initially randomized to a 125 mg per month dose as well, but interim analysis showed a very low response rate, and low dose groups were dropped.

Results of the trials, after a minimum follow-up duration of 14.6 months, are summarized in Table 14. The effectiveness of Fulvestrant 250 mg was determined by comparing Objective Response Rate (ORR) and Time to Progression (TTP) results to anastrozole 1 mg, the active control. The two studies ruled out (by one-sided 97.7% confidence limit) inferiority of Fulvestrant to anastrozole of 6.3% and 1.4% in terms of ORR. There was no statistically significant difference in overall survival (OS) between the two treatment groups after a follow-up duration of 28.2 months in Study 0021 and 24.4 months in Study 0020.

Table 14: Efficacy Results in Studies 0020 and 0021 (Objective Response Rate (ORR) and Time to Progression (TTP))

	Study 0021 (Double-Blind)		Study 0020 (Open-Label)	
	Fulvestrant	Anastrozole	Fulvestrant	Anastrozole
Endpoint	250 mg N=206	1 mg N=194	250 mg N=222	1 mg N=229
Objective Tumor Response Number (%) of subjects with CR ¹ + PR ²	35 (17.0)	33 (17.0)	45 (20.3)	34 (14.9)
% Difference in Tumor Response Rate (FAS ³ -ANA ⁴) 2-sided 95.4% CI ⁵	0.0 (-6.3, 8.9)		5.4 (-1.4, 14.8)	
Time to Progression (TTP) Median TTP (days)	165	103	166	156
Hazard Ratio ⁶ 2-sided 95.4% CI	0.9 (0.7, 1.1)		1.0 (0.8, 1.2)	
Stable Disease for ≥24 weeks (%)	26.7	19.1	24.3	30.1
Overall Survival (OS)				
Died n (%) Median Survival (days)	152 (73.8%) 844	149 (76.8%) 913	167 (75.2%) 803	173 (75.5%) 736
Hazard Ratio ⁶ (2-sided 95% CI)	0.98 (0.78, 1.24)		0.97 (0.78, 1.21)	

1. CR = Complete Response
2. PR = Partial Response
3. FAS = Fulvestrant
4. ANA = anastrozole
5. CI = Confidence Interval
6. Hazard Ratio <1 favors Fulvestrant

Combination Therapy

Patients with HR-positive, HER2-negative advanced or metastatic breast cancer who have had disease progression on or after prior adjuvant or metastatic endocrine therapy

Fulvestrant 500 mg in Combination with Palbociclib 125 mg (PALOMA-3)

PALOMA-3 (NCT-1942135) was an international, randomized, double-blind, parallel group, multi-center study of Fulvestrant plus palbociclib versus Fulvestrant plus placebo conducted in women with HR-positive, HER2-negative advanced breast cancer, regardless of their menopausal status, whose disease progressed on or after prior endocrine therapy.

A total of 521 pre/postmenopausal women were randomized 2:1 to Fulvestrant plus palbociclib or Fulvestrant plus placebo and stratified by documented sensitivity to prior hormonal therapy, menopausal status at study entry (pre/peri versus postmenopausal), and presence of visceral metastases. Palbociclib was given orally at a dose of 125 mg daily for 21 consecutive days followed by 7 days off treatment. Fulvestrant 500 mg was administered as two 5 mL injections each containing fulvestrant 250 mg/5mL, one in each buttock, on Days 1, 15, 29, and every 28 (+/-3) days thereafter. Pre/perimenopausal women were enrolled in the study and received the LHRH agonist goserelin for at least 4 weeks prior to and for the duration of PALOMA-3.

Patients continued to receive assigned treatment until objective disease progression, symptomatic deterioration, unacceptable toxicity, death, or withdrawal of consent, whichever occurred first. The major efficacy outcome of the study was investigator-assessed PFS evaluated according to RECIST v.1.1.

Patients enrolled in this study had a median age of 57 years (range 29 to 88). The majority of patients on study were White (74%), all patients had an ECOG PS of 0 or 1, and 80% were postmenopausal. All patients had received prior systemic therapy and 75% of patients had received a previous chemotherapy regimen. Twenty-five percent of patients had received no prior therapy in the metastatic disease setting, 60% had visceral metastases, and 23% had bone only disease.

The results from the investigator-assessed PFS and final OS data from PALOMA-3 are summarized in Table 15. The relevant Kaplan-Meier plots are shown in Figures 9 and 10, respectively. Consistent PFS results were observed across patient subgroups of disease site, sensitivity to prior hormonal therapy, and menopausal status. After a median follow-up time of 45 months, the final OS results were not statistically significant.

Table 15: Efficacy Results in PALOMA-3 (Investigator Assessment, ITT Population)

	Fulvestrant plus Palbociclib	Fulvestrant plus Placebo
Progression-Free Survival for ITT	N=347	N=174
Number of PFS Events (%)	145 (41.8%)	114 (65.5%)
Median PFS (months) (95% CI)	9.5 (9.2-11.0)	4.6 (3.5-5.6)
Hazard Ratio (95% CI) and p-value	0.461 (0.360-0.591) p <0.0001	
Objective Response for Patients with Measurable Disease	N=267	N=138
Objective response rate ¹ (%; 95% CI)	24.6 (19.6-30.2)	10.9 (6.2-17.3)
Overall Survival for ITT population	N=347	N=174
Number of OS events (%)	201 (57.9)	109 (62.6)
Median OS (months) (95% CI)	34.9 (28.8, 40.0)	28.0 (23.6, 34.6)
Hazard Ratio (95% CI) and p-value	0.814 (0.644, 1.029), p=0.0857 ^{2,3}	

N=number of patients; PFS=progression-free survival; CI=confidence interval; ITT=Intent-to-Treat; OS=overall survival.

¹. Responses are based on confirmed responses.

². Not statistically significant at the pre-specified 2-sided alpha level of 0.047.

³. 2-sided p-value from the log-rank test stratified by the presence of visceral metastases and sensitivity to prior endocrine therapy per randomization.

Figure 9 Kaplan-Meier Plot of Progression-Free Survival (Investigator Assessment, ITT Population) – PALOMA-3

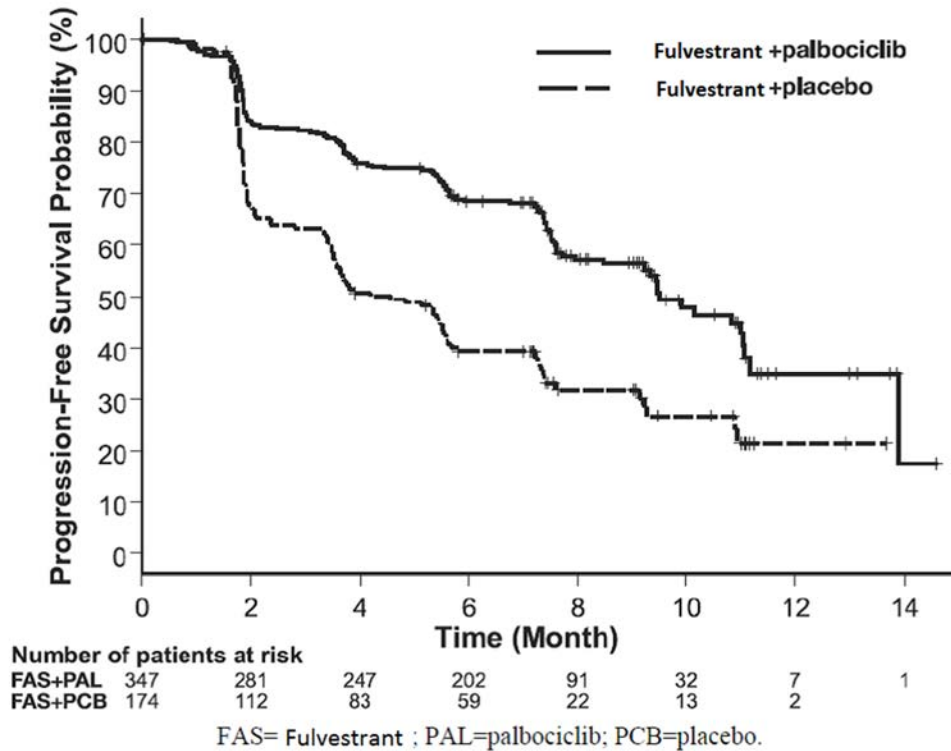
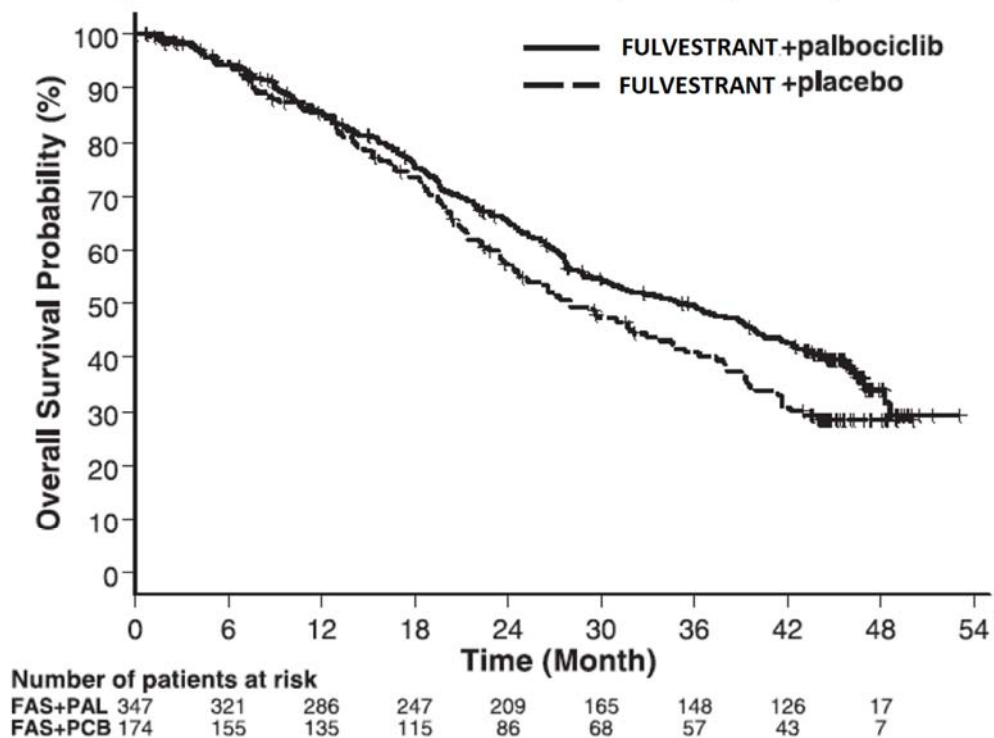

Figure 10 Kaplan-Meier Plot of Overall Survival (ITT Population) – PALOMA-3



FAS=FULVESTRANT; PAL=palbociclib; PCB=placebo

Fulvestrant 500 mg in Combination with Abemaciclib 150 mg (MONARCH 2)

MONARCH 2 (NCT02107703) was a randomized, placebo-controlled, multi-center study conducted in women with HR-positive, HER2-negative metastatic breast cancer with disease progression following endocrine therapy treated with Fulvestrant plus abemaciclib versus Fulvestrant plus placebo. Randomization was stratified by disease site (visceral, bone only, or other) and by sensitivity to prior endocrine therapy (primary or secondary resistance). A total of 669 patients received intramuscular injection of Fulvestrant 500 mg on Days 1 and 15 of cycle 1 and then on Day 1 of cycle 2 and beyond (28-day cycles), plus abemaciclib or placebo orally twice daily. Pre/perimenopausal women were enrolled in the study and received the gonadotropin-releasing hormone agonist goserelin for at least 4 weeks prior to and for the duration of MONARCH 2. Patients remained on continuous treatment until development of progressive disease or unmanageable toxicity.

Patient median age was 60 years (range, 32-91 years), and 37% of patients were older than 65. The majority were White (56%), and 99% of patients had an Eastern Cooperative Oncology Group (ECOG) performance status of 0 or 1. Twenty percent (20%) of patients had de novo metastatic disease, 27% had bone only disease, and 56% had visceral disease. Twenty-five percent (25%) of patients had primary endocrine therapy resistance. Seventeen percent (17%) of patients were pre-or perimenopausal.

The efficacy results from the MONARCH 2 study are summarized in Table 16, Figure 11, and Figure 12. PFS assessment based on a blinded independent radiologic review was consistent with the investigator assessment. Consistent results were observed across patient stratification subgroups of disease site and endocrine therapy resistance for PFS and OS.

Table 16: Efficacy Results in MONARCH 2 (Intent-to-Treat Population)

	Fulvestrant plus Abemaciclib	Fulvestrant plus Placebo
Progression-Free Survival (Investigator Assessment)	N=446	N=223
Number of patients with an event (n, %)	222 (49.8)	157 (70.4)
Median (months, 95% CI)	16.4 (14.4, 19.3)	9.3 (7.4, 12.7)
Hazard ratio (95% CI) ¹	0.553 (0.449, 0.681)	
p-value ¹	p<0.0001	
Overall Survival²		
Number of deaths (n, %)	211 (47.3)	127 (57.0)
Median OS in months (95% CI)	46.7 (39.2, 52.2)	37.3 (34.4, 43.2)
Hazard ratio (95% CI) ¹	0.757 (0.606, 0.945)	
p-value ¹	p=0.0137	
Objective Response for Patients with Measurable Disease	N=318	N=164
Objective response rate ³ (n, %)	153 (48.1)	35 (21.3)
95% CI	42.6, 53.6	15.1, 27.6

Abbreviations: CI=confidence interval, OS=overall survival.

1. Stratified by disease site (visceral metastases vs. bone-only metastases vs. other) and endocrine therapy resistance (primary resistance vs. secondary resistance)
2. Data from a pre-specified interim analysis (77% of the number of events needed for the planned final analysis) with the p-value compared with the allocated alpha of 0.021.
3. Complete response + partial response.

Figure 11 Kaplan-Meier Curves of Progression-Free Survival: Fulvestrant Plus Abemaciclib versus Fulvestrant plus Placebo (MONARCH 2)

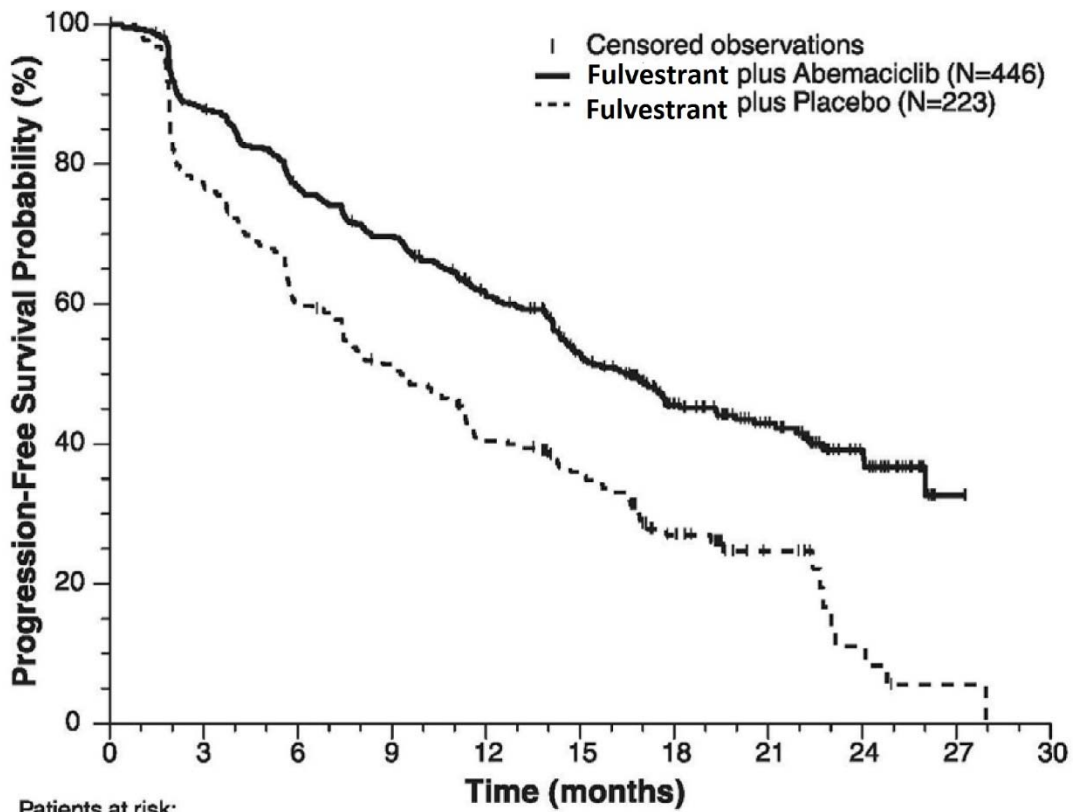

Patients at risk:

	0	3	6	9	12	15	18	21	24	27	30
Fulvestrant plus Abemaciclib	446	367	314	281	234	171	101	65	32	2	0
Fulvestrant plus Placebo	223	165	123	103	80	61	32	13	4	1	0

Figure 12 Kaplan-Meier Curves of Overall Survival: Fulvestrant plus Abemaciclib versus Fulvestrant plus Placebo (MONARCH 2)

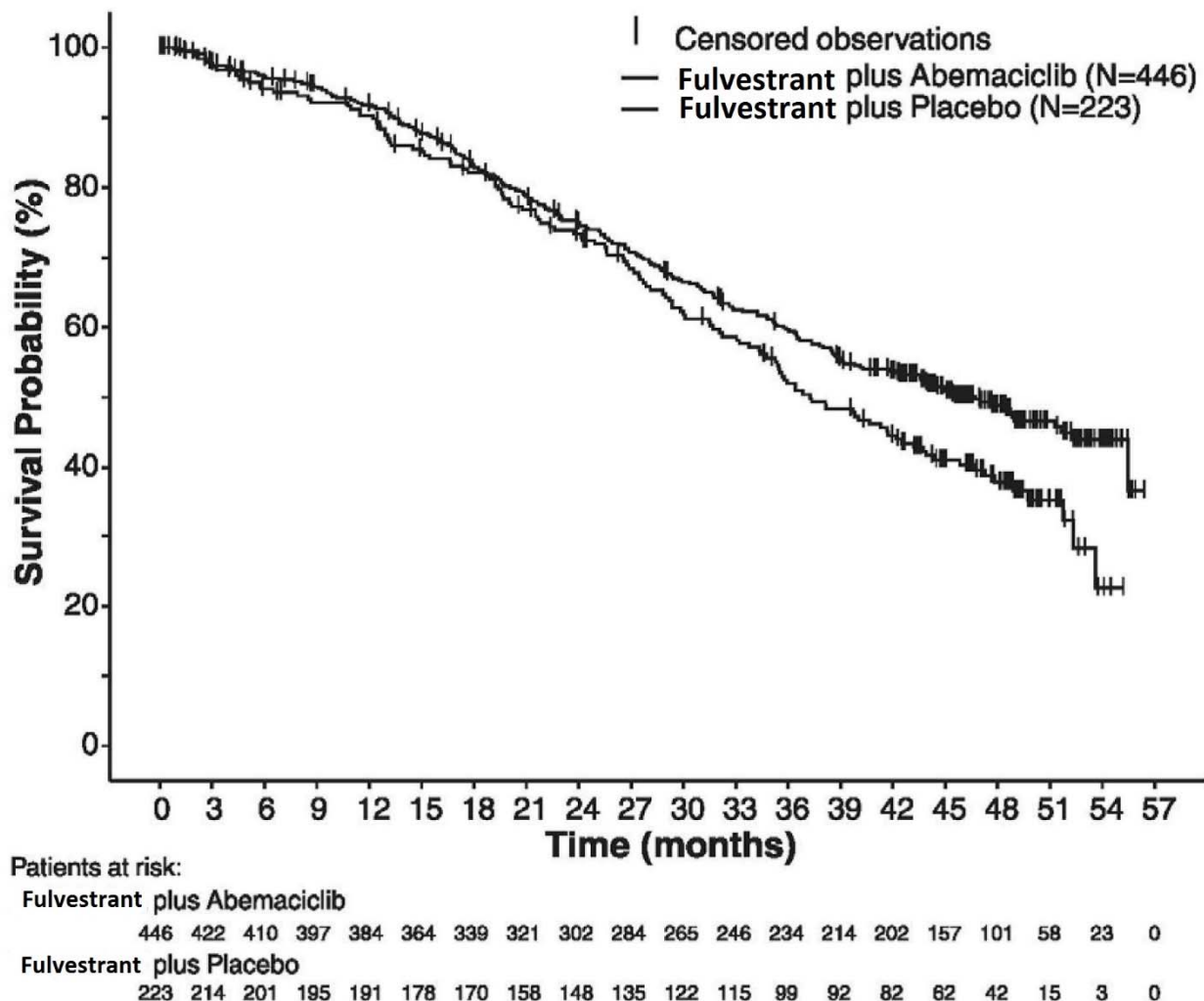

Postmenopausal women with HR-positive, HER2-negative advanced or metastatic breast cancer for initial endocrine based therapy or after disease progression on endocrine therapy

Fulvestrant 500 mg in Combination with Ribociclib 600 mg (MONALEESA-3)

MONALEESA-3 (NCT 02422615) was a randomized double-blind, placebo-controlled study of Fulvestrant plus ribociclib versus Fulvestrant plus placebo conducted in postmenopausal women with hormone receptor positive, HER2-negative, advanced breast cancer who have received no or only one line of prior endocrine treatment.

A total of 726 patients were randomized in a 2:1 ratio to receive Fulvestrant plus ribociclib or Fulvestrant plus placebo and stratified according to the presence of liver and/or lung metastases and prior endocrine therapy for advanced or metastatic disease. Fulvestrant 500 mg was

administered intramuscularly on Days 1, 15, 29, and once monthly thereafter, with either ribociclib 600 mg or placebo given orally once daily for 21 consecutive days followed by 7 days off until disease progression or unacceptable toxicity. The major efficacy outcome measure for the study was investigator-assessed progression-free survival (PFS) using Response Evaluation Criteria in Solid Tumors (RECIST) v1.1.

Patients enrolled in this study had a median age of 63 years (range 31 to 89). Of the patients enrolled, 47% were 65 years and older, including 14% age 75 years and older. The patients enrolled were primarily Caucasian (85%), Asian (9%), and Black (0.7%). Nearly all patients (99.7%) had an ECOG performance status of 0 or 1. First- and second-line patients were enrolled in this study (of which 19% had *de novo* metastatic disease). Forty-three percent (43%) of patients had received chemotherapy in the adjuvant vs. 13% in the neoadjuvant setting and 59% had received endocrine therapy in the adjuvant vs. 1% in the neoadjuvant setting prior to study entry. Twenty-one percent (21%) of patients had bone-only disease and 61% had visceral disease. Demographics and baseline disease characteristics were balanced and comparable between study arms.

The efficacy results from MONALEESA-3 are summarized in Table 17, Figure 13, and Figure 14. Consistent results were observed in stratification factor subgroups of disease site and prior endocrine treatment for advanced disease.

Table 17: Efficacy Results – MONALEESA-3 (Investigator Assessment, Intent-to-Treat Population)

	Fulvestrant plus Ribociclib	Fulvestrant plus Placebo
Progression-free survival*	N=484	N=242
Events (n, %)	210 (43.4%)	151 (62.4%)
Median (months, 95% CI)	20.5 (18.5, 23.5)	12.8 (10.9, 16.3)
Hazard Ratio (95% CI)	0.593 (0.480 to 0.732)	
p-value ¹	<0.0001	
Overall Survival	N=484	N=242
Events (n, %)	167 (34.5%)	108 (44.6%)
Median (months, 95% CI)	NR (42.5, NR)	40.0 (37.0, NR)
Hazard Ratio (95% CI)	0.724 (0.568, 0.924)	
p-value ¹	0.00455	
Overall Response Rate^{2*}	N=379	N=181
Patients with measurable disease (95% CI)	40.9 (35.9, 45.8)	28.7 (22.1, 35.3)

Abbreviation: NR, not reached

1. p-value is obtained from the one-sided log-rank

2. Based on confirmed responses

*Investigator Assessment

Figure 13 Kaplan-Meier Progression Free Survival Curves – MONALEESA-3 (Intent-To-Treat Population, Investigator assessment)

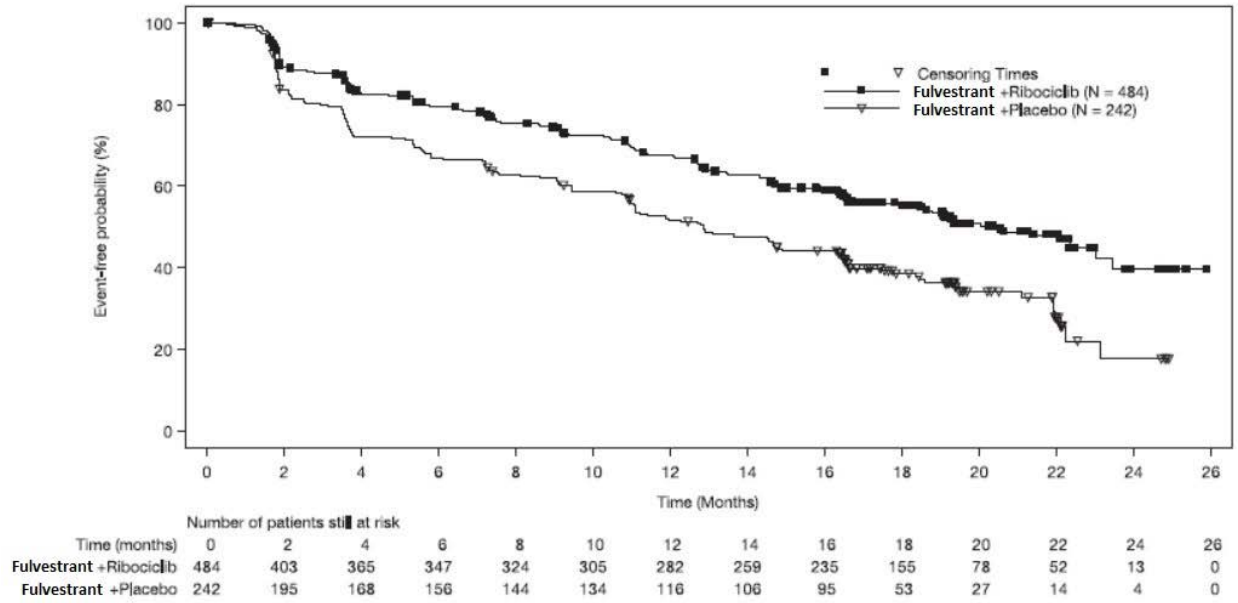
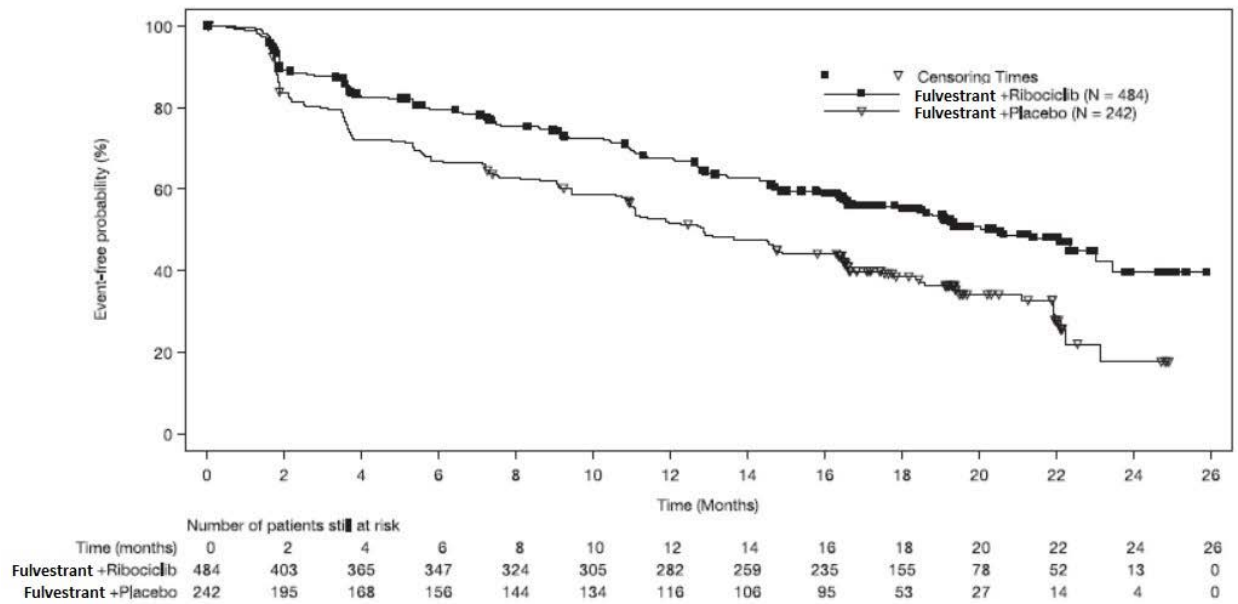

Figure 14 Kaplan-Meier plot of Overall Survival – MONALEESA-3 (Intent -to-Treat Population)



16 HOW SUPPLIED/STORAGE AND HANDLING

Fulvestrant injection is supplied as two 5 mL clear glass (Type 1) barrels, each containing 250 mg/5 mL of Fulvestrant solution for intramuscular injection and fitted with a tamper evident closure. Fulvestrant Injection is a clear, colorless to yellow, viscous solution.

NDC 16729-436-31

Two pre-filled syringes each containing 250 mg/5 mL of Fulvestrant solution for intramuscular injection and two safety needles (SafetyGlide™) are packaged per carton with NDC 16729-436-30

The single-dose prefilled syringes are presented in a tray with polypropylene plunger rod and safety needles (SafetyGlide™) for connection to the barrel.

Discard each syringe after use. If a patient dose requires only one syringe, unused syringe should be stored as directed below.

Storage:

REFRIGERATE, 2°C TO 8°C (36°F TO 46°F). TO PROTECT FROM LIGHT, STORE IN THE ORIGINAL CARTON UNTIL TIME OF USE.

17 PATIENT COUNSELING INFORMATION

Advise the patient to read the FDA-approved patient labeling (Patient Information)

Monotherapy

Risk of Bleeding:

- Because Fulvestrant injection is administered intramuscularly, it should be used with caution in patients with bleeding disorders, decreased platelet count, or in patients receiving anticoagulants (for example, warfarin) [*see Warnings and Precautions (5.1)*].

Embryo-Fetal Toxicity:

- Advise females of reproductive potential of the potential risk to a fetus and to use effective contraception during treatment with Fulvestrant injection and for one year after the last dose. Advise females to inform their healthcare provider of a known or suspected pregnancy [*see Warnings and Precautions (5.4) and Use in Specific Populations (8.1), (8.3)*].

Lactation:

- Advise women not to breastfeed during treatment with Fulvestrant injection and for one year after the last dose [*see Use in Specific Populations (8.2)*].

Combination Therapy

When Fulvestrant injection is used in combination with palbociclib, abemaciclib, or ribociclib, refer to the respective Full Prescribing Information for Patient Counseling Information.

Manufactured For:

Accord Healthcare, Inc.,
1009, Slater Road,
Suite 210-B,
Durham, NC 27703,
USA.

Manufactured By:

Intas Pharmaceuticals Limited,
Plot No.: 457, 458,
Village – Matoda,
Bavla Road, Ta. - Sanand,
Dist.- Ahmedabad – 382 210.
India.

10 2433 0 678184

PATIENT INFORMATION

Fulvestrant injection

What is Fulvestrant injection?

Fulvestrant injection is a prescription medicine used to treat advanced breast cancer or breast cancer that has spread to other parts of the body (metastatic).

Fulvestrant injection may be used alone, if you have gone through menopause, and your advanced breast cancer is:

- hormone receptor (HR)-positive and human epidermal growth factor receptor 2 (HER2)-negative and has not been previously treated with endocrine therapy

or

- HR-positive and has progressed after endocrine therapy.

Fulvestrant injection may be used in combination with ribociclib, if you have gone through menopause, and your advanced or metastatic breast cancer is HR-positive and HER2-negative, and has not been previously treated with endocrine therapy or has progressed after endocrine therapy.

Fulvestrant injection may be used in combination with palbociclib or abemaciclib if your advanced or metastatic breast cancer is HR-positive and HER2-negative, and has progressed after endocrine therapy.

When Fulvestrant injection is used in combination with palbociclib, abemaciclib, or ribociclib, also read the Patient Information for the prescribed product.

It is not known if Fulvestrant injection is safe and effective in children.

It is not known if Fulvestrant injection is safe and effective in people with severe liver problems.

Who should not receive Fulvestrant injection?

Do not receive Fulvestrant injection if you have had an allergic reaction to fulvestrant or any of the ingredients in Fulvestrant injection. See the end of this leaflet for a list of the ingredients in Fulvestrant injection.

Symptoms of an allergic reaction to Fulvestrant injection may include:

- itching or hives
- swelling of your face, lips, tongue or throat
- trouble breathing

What should I tell my healthcare provider before receiving Fulvestrant injection?

Before receiving Fulvestrant injection, tell your healthcare provider about all of your medical conditions, including if you:

- have a low level of platelets in your blood or bleed easily.
- have liver problems.
- are pregnant or plan to become pregnant. Fulvestrant injection can harm your unborn baby.

Females who are able to become pregnant:

- Your healthcare provider may perform a pregnancy test within 7 days before you start Fulvestrant injection.
 - You should use effective birth control during treatment with Fulvestrant injection and for one year after the last dose of Fulvestrant injection.
 - Tell your healthcare provider right away if you become pregnant or think you are pregnant during treatment with Fulvestrant injection.
- are breastfeeding or plan to breastfeed. It is not known if Fulvestrant injection passes into your breast milk. Do not breastfeed during your treatment with Fulvestrant injection and for one year after the final dose of Fulvestrant injection. Talk to your healthcare provider about the best way to feed your baby during this time.

Tell your healthcare provider about all the medicines you take, including prescription and over-the-counter medicines, vitamins, and herbal supplements. Fulvestrant injection may affect the way other medicines work, and other medicines may affect how Fulvestrant injection works. **Especially tell your healthcare provider** if you take a blood thinner medicine.

How will I receive Fulvestrant injection?

- Your healthcare provider will give you Fulvestrant injection by injection into the muscle of each buttock.
- Your healthcare provider may change your dose of Fulvestrant injection if needed.

What are the possible side effects of Fulvestrant injection?

Fulvestrant injection may cause serious side effects, including:

- **Injection site related nerve damage.** Call your healthcare provider if you develop any of the following symptoms in your legs following a Fulvestrant injection:
 - numbness
 - tingling
 - weakness

The most common side effects of Fulvestrant injection include:

- injection site pain
- nausea
- muscle, joint, and bone pain
- headache
- back pain
- tiredness
- pain in arms, hands, legs, or feet
- hot flashes
- vomiting
- loss of appetite
- weakness
- cough
- shortness of breath
- constipation
- increased liver enzymes
- diarrhea

Fulvestrant injection may cause fertility problems in males and females. Talk to your healthcare provider if you plan to become pregnant.

Tell your healthcare provider if you have any side effect that bothers you or that does not go away. These are not all of the possible side effects with Fulvestrant injection. For more information, ask your healthcare provider or pharmacist.

Call your healthcare provider for medical advice about side effects. You may report side effects to FDA at 1-800-FDA-1088.

General information about the safe and effective use of Fulvestrant injection

Medicines are sometimes prescribed for purposes other than those listed in a Patient Information leaflet. If you would like more information, talk with your healthcare provider. You can ask your pharmacist or healthcare provider for information about Fulvestrant injection that is written for health professionals.

What are the ingredients in Fulvestrant injection?

Active ingredient: fulvestrant.

Inactive ingredients: alcohol, benzyl alcohol, benzyl benzoate, and castor oil.

SafetyGlide™ is a trademark of Becton Dickinson and Company.

Manufactured For:

Accord Healthcare, Inc.,
1009, Slater Road,
Suite 210-B,
Durham, NC 27703,
USA.

Manufactured By:

Intas Pharmaceuticals Limited,
Plot No.: 457, 458,
Village – Matoda,
Bavla Road, Ta. - Sanand,
Dist.- Ahmedabad – 382 210.
India.

10 2433 0 678184

This Patient Information has been approved by the U.S. Food and Drug Administration

Issued: 8/2020